



KERN & Sohn GmbH

Ziegelei 1
D-72336 Balingen
E-Mail: info@kern-sohn.com

Phone: +49-[0]7433- 9933-0
Fax: +49-[0]7433-9933-149
Internet: www.kern-sohn.com

Operating manual Analytical Precision Balance

KERN AEJ-C/AES-C/PLJ-C

Version 1.4
10/2015
GB



AEJ-C/AES-C/PLJ-C-BA-e-1514



KERN AEJ-C/AES-C/PLJ-C

Version 1.4 10/2015

Operating manual

Analytical Precision Balance

Contents

1	Technical data	5
1.1	Dimensions	9
2	Appliance overview	10
2.1	Display and Keyboard Summary	13
2.1.1	Navigation buttons / numeric input	15
3	Basic instructions	16
3.1	Proper use	16
3.2	Improper Use	16
3.3	Warranty	16
3.4	Monitoring of Test Resources	17
4	Basic Safety Precautions	17
4.1	Pay attention to the instructions in the Operation Manual	17
4.2	Personnel training	17
5	Transport and storage	17
5.1	Testing upon acceptance	17
5.2	Packaging / return transport	17
6	Unpacking, Setup and Commissioning	20
6.1	Installation Site, Location of Use	20
6.2	Unpacking and checking	20
6.3	Placing	21
6.4	Mains connection	24
6.4.1	Turning On the Power	24
6.5	Connection of peripheral devices	24
6.6	Initial Commissioning	24
7	Adjustment	25
7.1	Automatic adjustment with internal weight (only AEJ-C and PLJ-C)	26
7.2	Menu settings	27
7.2.1	P1.1 INT.JUST. - internal adjustment (only models AEJ-C and PLJ-C)	27
7.2.2	P1.2 EXT.JUST.- external adjustment (only AES-C)	28
7.2.3	P1.3 BE.JUST. User adjustment (model AES-C only)	29
7.2.4	P1.4 TEST JUST. – adjustment report (only models AEJ-C and PLJ-C)	30
7.2.5	Printing adjustment reports	31
7.3	Verification	32

8	Menu	34
8.1	Navigation in the menu	34
8.2	Menu overview	35
8.3	Exit menu / back to weighing mode.	40
9	Entry by navigation keys	41
10	User	42
10.1	Login/logout	42
10.2	Authorisation levels	43
11	Weighing	44
11.1	Switch on-off balance	44
11.2	Weighing	44
11.3	Weighing units switch-over	45
11.4	Taring.....	45
11.4.1	Entering a tare value manually (pre-tare)	45
11.4.2	Deleting the tare value	45
11.5	Underfloor weighing.....	46
11.6	Selecting the operating mode	47
11.6.1	Invoking operating modes:.....	47
11.6.2	To select operating modes:	48
12	Weighing scale settings operating mode weighing	49
12.1	Filter - adaptation to ambient conditions and weighing options	49
12.2	Rest position control.....	50
12.3	Auto Zero.....	51
12.4	Hide last decimal place	52
12.5	Environmental conditions	53
12.6	Print mode	54
12.7	Information display	55
12.7.1	Special information	56
12.7.2	Shortcut keys	57
13	Additional operating modes	58
13.1	Parts counting	58
13.2	Weighing with tolerance range	63
13.3	Dosing.....	66
13.4	Percent determination.....	69
13.5	Animal weighing	71
13.6	Statistics.....	73
13.7	Totalization.....	76
13.8	HOLD function	79

14	Further useful functions “P6 OTHER“	80
14.1	Language.....	80
14.2	Authorisations	81
14.3	Acoustic signal for key operation.....	82
14.4	Backlight and brightness control for display	83
14.5	Date.....	84
14.6	Time	85
14.7	Date format.....	86
14.8	Time format	87
15	Weighing units	88
15.1	How to enable weighing units.....	88
15.2	How to set a standard weight unit	89
16	GLP/ISO report “P5.3 GLP PRINT“	90
17	Data output RS 232 and USB	92
17.1	Technical data.....	92
17.2	Setting interface RS 232	93
17.3	Interface cable	94
17.4	Output log	94
17.4.1	Issue after pressing the PRINT 'button	94
17.4.2	Remote control instructions	95
18	Connecting external devices	97
18.1	Printer settings	98
18.1.1	Setting an adjustment report.....	99
18.1.2	Set header	100
18.1.3	Print measured result.....	101
18.1.4	Adjust footer.....	101
19	Data bases	102
19.1	Data base USER.....	102
19.2	Data base products	106
19.3	Data base Taring.....	109
19.4	Data base Weighing processes	110
19.5	Alibi memory.....	113
19.6	Exporting and importing data bases	114
20	Servicing, maintenance, disposal	117
20.1	Clean.....	117
20.2	Servicing, maintenance	117
20.3	Disposal.....	117
22	Instant help	118
22.1	Error messages	119
23	Declaration of conformity	120

1 Technical data

KERN	AEJ 100-4CM	AEJ 200-4CM	AEJ 200-5CM
Readability (d)	0.1 mg	0.1 mg	0.01 mg; 0.1 mg
Weighing range (max)	160 g	220 g	82 g; 220 g
Minimum load (Min)	10 mg	10 mg	1 mg
Verification value (e)	1 mg	1 mg	1 mg; 1 mg
Verification class	I	I	I
Reproducibility	0.2 mg	0.2 mg	0.04 mg; 0.1 mg
Linearity	± 0.3 mg	± 0.3 mg	± 0.1 mg; 0.2 mg
Stabilization time	4 sec.	4 sec.	6 sec; 3.5sec.
Adjustment weight	internal	internal	internal
Warm-up time	8 h	8 h	8 h; 8 h
Weighing Units	g, mg, ct	g, mg, ct	g, mg, ct
Smallest part weight for piece counting	0.1 mg	0.1 mg	0.1 mg
Reference quantities at piece counting	10, 20, 50, freely selectable	10, 20, 50, freely selectable	10, 20, 50, freely selectable
Weighing plate, stainless steel [cm]	Ø 10	Ø 10	Ø 8.5
Net weight (kg)	5.4	5.4	5.4
Permissible ambient condition	+10° C to +40° C	+10° C to +40° C	+10° C to +40° C
Humidity of air	80 % relative (not condensing)	80 % relative (not condensing)	80 % relative (not condensing)
Input voltage	110 - 230 V AC,	110 - 230 V AC,	110 - 230 V AC,
Power pack secondary voltage	13.5 V – 16 V	13.5 V – 16 V	13.5 V – 16 V
Interface	RS 232C; USB	RS 232C; USB	RS 232C; USB
Underfloor weighing device	Hooks	Hooks	Hooks

KERN	AES 100-4C	AES 200-4C
Readability (d)	0.1 mg	0.1 mg
Weighing range (max)	160 g	220 g
Reproducibility	0.2 mg	0.2 mg
Linearity	± 0.2 mg	± 0.2 mg
Stabilization time	4 sec.	4 sec.
Recommended adjusting weight not supplied (class)	150 g (E2)	200 g (E2)
Warm-up time	8 h	8 h
Weighing Units	ct, dwt, g, gn, mg, oz	ct, dwt, g, gn, mg, oz
Smallest part weight for piece counting	0.5 mg	0.5 mg
Reference quantities at piece counting	10, 20, 50, freely selectable	10, 20, 50, freely selectable
Weighing plate, stainless steel [cm]	Ø 10	Ø 10
Net weight (kg)	5.4	5.4
Permissible ambient condition	+18° C to +30° C	+18° C to +30° C
Humidity of air	80 % relative (not condensing)	80 % relative (not condensing)
Input voltage	110 - 230 V AC,	110 - 230 V AC,
Power pack secondary voltage	13.8 V	13.8 V
Interface	RS 232C; USB	RS 232C; USB
Underfloor weighing device	Hooks	Hooks

KERN	PLJ 300-3CM	PLJ 600-3CM
Readability (d)	1 mg	1 mg
Weighing range (max)	360 g	600 g
Minimum load (Min)	20 mg	20 mg
Verification value (e)	10 mg	10 mg
Verification class	II	II
Reproducibility	1 mg	2 mg
Linearity	± 4 mg	± 4 mg
Stabilization time	4 sec.	4 sec.
Adjustment weight	internal	internal
Warm-up time	2 h	4 h
Weighing Units	ct, g, kg	ct, g, kg
Smallest part weight for piece counting	5 mg	5 mg
Reference quantities at piece counting	10, 20, 50, freely selectable	10, 20, 50, freely selectable
Weighing plate, stainless steel [mm]	128 x 128	128 x 128
Net weight (kg)	4.6	4
Permissible ambient condition	+10° C bis +40° C	+10° C bis +40° C
Humidity of air	80 % relative (not condensing)	80 % relative (not condensing)
Input voltage	100 - 240 V	100 - 240 V
Power pack secondary voltage	13.5 V – 16 V	13.5 V – 16 V
Interface	RS 232C; USB	RS 232C; USB
Underfloor weighing device	Hooks	Hooks

KERN	PLJ 700-3CM	PLJ 3000-2CM
Readability (d)	1 mg	10 mg
Weighing range (max)	750 g	3500 g
Minimum load (Min)	20 mg	500 mg
Verification value (e)	10 mg	100 mg
Verification class	II	II
Reproducibility	2 mg	10 mg
Linearity	± 4 mg	± 40 mg
Stabilization time	4 sec.	4 sec.
Adjustment weight	internal	
Warm-up time	4 h	2 h
Weighing Units	ct, g, kg	
Smallest part weight for piece counting	5 mg	
Reference quantities at piece counting	10, 20, 50, freely selectable	
Weighing plate, stainless steel [mm]	128 x 128	195 x 195
Net weight (kg)	3.5	4.4
Permissible ambient condition	+10° C bis +40° C	
Humidity of air	80 % relative (not condensing)	
Input voltage	100 - 240 V	
Power pack secondary voltage	13.5 V – 16 V	
Interface	RS 232C; USB	
Underfloor weighing device	Hooks	

1.1 Dimensions

AEJ-C/AES-C:

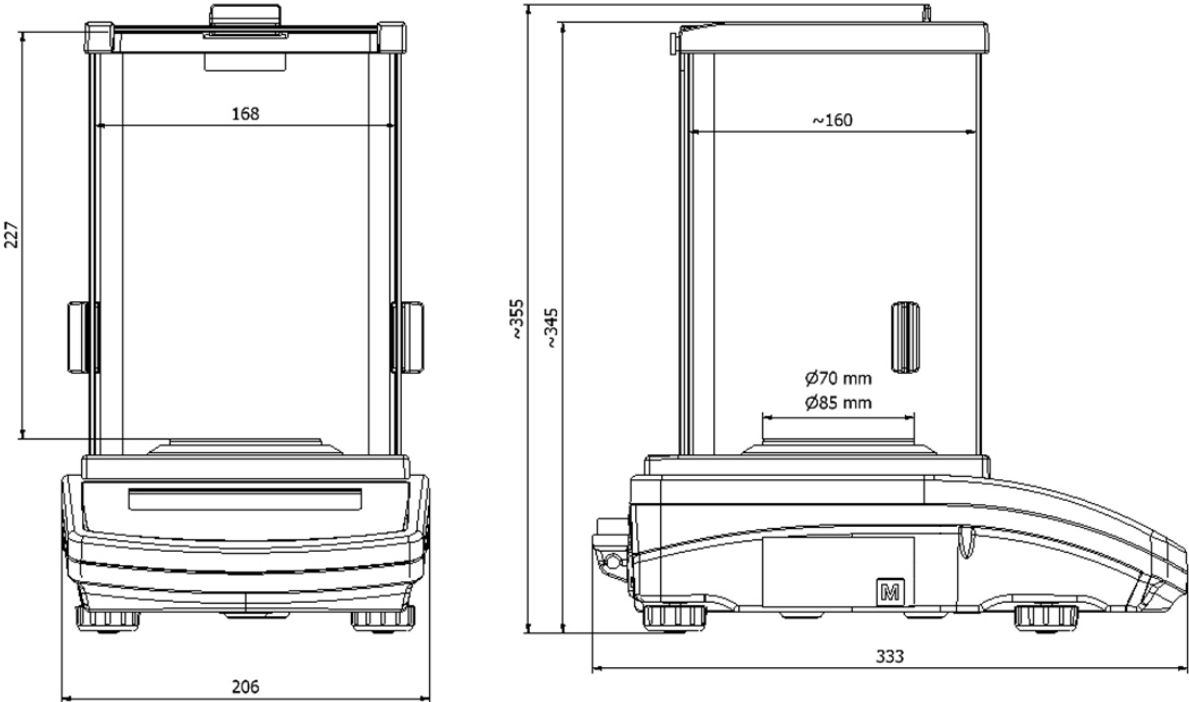

PLJ-C:

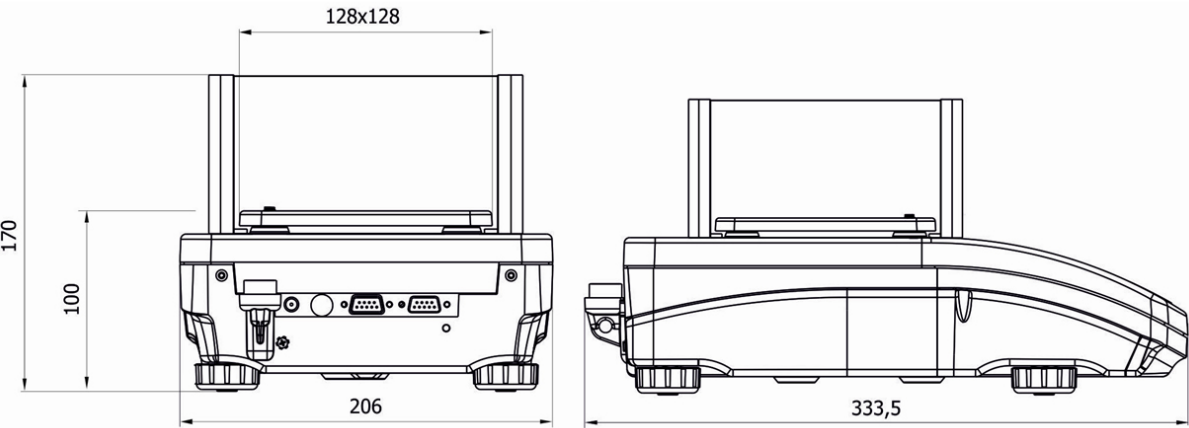

2 Appliance overview

KERN AEJ/AES-C:



1. Glass wind screen
2. Weighing pan
3. Display
4. Keyboard
5. Levelling screw

KERN PLJ-C:



1. Glass wind screen
2. Weighing pan
3. Display
4. Keyboard
5. Levelling screw

Connections (all models):

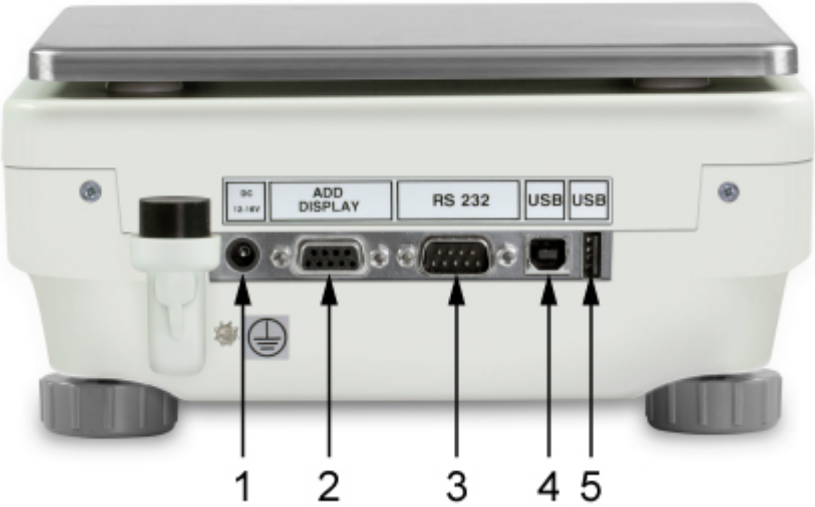

- 1. Mains connection
- 2. COM 2 connection
- 3. COM 1 connection
- 4. USB 2 connection
- 5. USB 1 connection







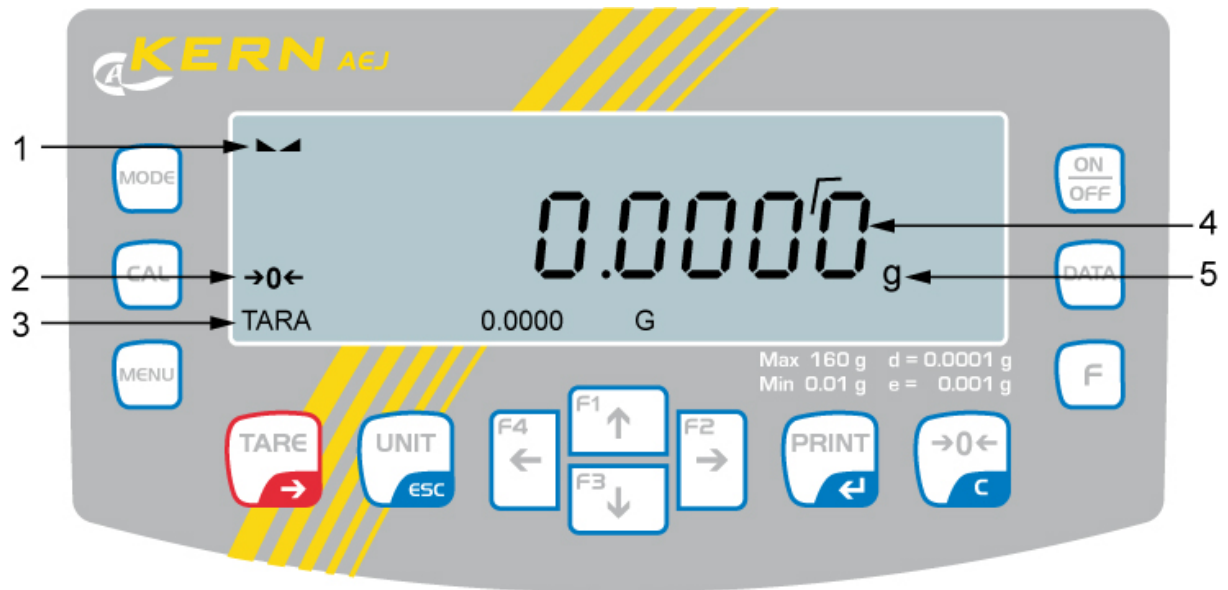



English

2.1 Display and Keyboard Summary





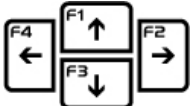

Example AEJ-C:



1. Stability display
2. Zero indicator
3. Information line
4. The non-verified value is given in brackets in verified scales.
5. Weighing unit "g"

Button	Function
	<ul style="list-style-type: none"> • Turn on/off
	<ul style="list-style-type: none"> • Invoke data bases
	<ul style="list-style-type: none"> • Function key
	<ul style="list-style-type: none"> • Selection of operating mode
	<ul style="list-style-type: none"> • Invoke adjustment
	<ul style="list-style-type: none"> • Call up menu
	<ul style="list-style-type: none"> • Taring
	<ul style="list-style-type: none"> • Switch-over weighing unit • In menu: Return to weighing mode
	<ul style="list-style-type: none"> • Scroll backwards in menu • Scroll forward in menu • Navigation keys see chap. 2.1.1
	<ul style="list-style-type: none"> • Calculate weighing data via interface • Confirm/save in menu
	<ul style="list-style-type: none"> • Zeroing • Delete entry in data base

2.1.1 Navigation buttons / numeric input

Button	Designation	Function
	Navigation button ↑	Increase flashing digit
	Navigation button ↓	Decrease flashing digit
	Navigation button →	Digit selection to the right
	Navigation button ←	Digit selection to the left
	Navigation button ↵	Confirm entry
	ESC	Cancel input

3 Basic instructions

3.1 Proper use

The balance you purchased is intended to determine the weighing value of material to be weighed. It is intended to be used as a “non-automatic balance”, i.e. the material to be weighed is manually and carefully placed in the centre of the weighing pan. As soon as a stable weighing value is reached the weighing value can be read.

3.2 Improper Use

Do not use balance for dynamic add-on weighing procedures, if small amounts of goods to be weighed are removed or added. The “stability compensation“ installed in the balance may result in displaying an incorrect measuring value! (Example: Slowly draining fluids from a container on the balance.)

Do not leave permanent load on the weighing pan. This may damage the measuring system.

Impacts and overloading exceeding the stated maximum load (max) of the balance, minus a possibly existing tare load, must be strictly avoided. Balance may be damaged by this.

Never operate balance in explosive environment. The serial version is not explosion protected.

The structure of the balance may not be modified. This may lead to incorrect weighing results, safety-related faults and destruction of the balance.

The balance may only be used according to the described conditions. Other areas of use must be released by KERN in writing.

3.3 Warranty

Warranty claims shall be voided in case

- Our conditions in the operation manual are ignored
- The appliance is used outside the described uses
- The appliance is modified or opened
- Mechanical damage or damage by media, liquids, natural wear and tear
- The appliance is improperly set up or incorrectly electrically connected
- The measuring system is overloaded

3.4 Monitoring of Test Resources

In the framework of quality assurance the measuring-related properties of the balance and, if applicable, the testing weight, must be checked regularly. The responsible user must define a suitable interval as well as type and scope of this test. Information is available on KERN's home page (www.kern-sohn.com) with regard to the monitoring of balance test substances and the test weights required for this. In KERN's accredited DKD calibration laboratory test weights and balances may be calibrated (return to the national standard) fast and at moderate cost.

4 Basic Safety Precautions

4.1 Pay attention to the instructions in the Operation Manual



- ⇒ Carefully read this operation manual before setup and commissioning, even if you are already familiar with KERN balances.
- ⇒ All language versions contain a non-binding translation. The original German is binding.

4.2 Personnel training

The appliance may only be operated and maintained by trained personnel.

5 Transport and storage

5.1 Testing upon acceptance

When receiving the appliance, please check packaging immediately, and the appliance itself when unpacking for possible visible damage.

5.2 Packaging / return transport

- ⇒ Keep all parts of the original packaging for a possibly required return.
- ⇒ Only use original packaging for returning.

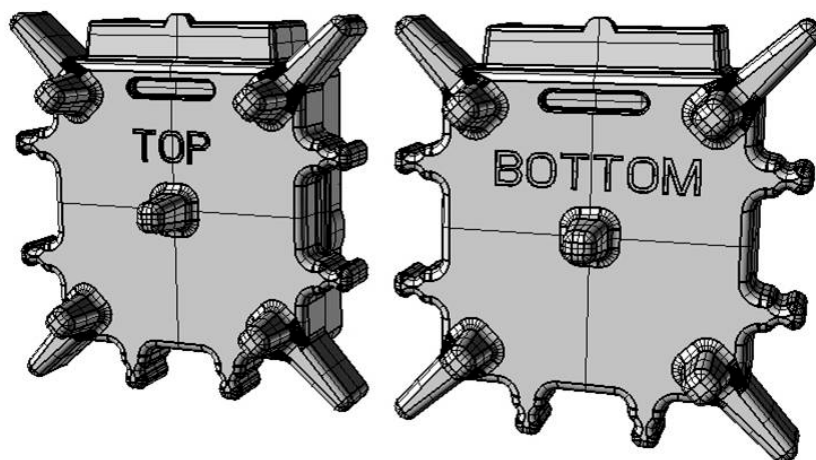

- ⇒ Prior to dispatch disconnect all cables and remove loose/mobile parts.

Figure example KERN AEJ/AES-C

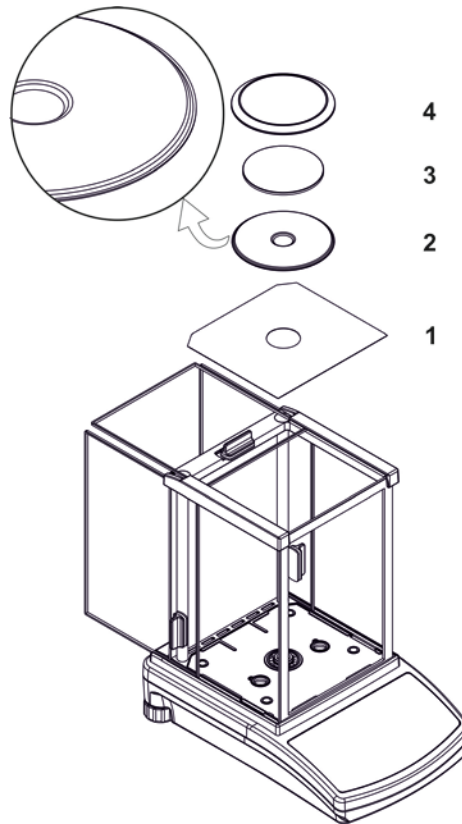

- ⇒ Reattach possibly supplied transport securing devices.
- ⇒ Secure all parts such as the glass wind screen, the weighing platform, power unit etc. against shifting and damage.

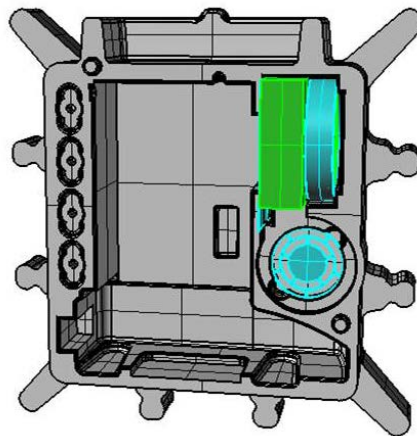

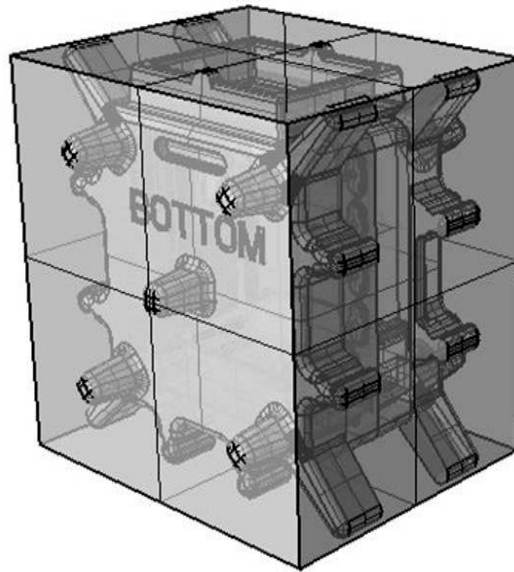
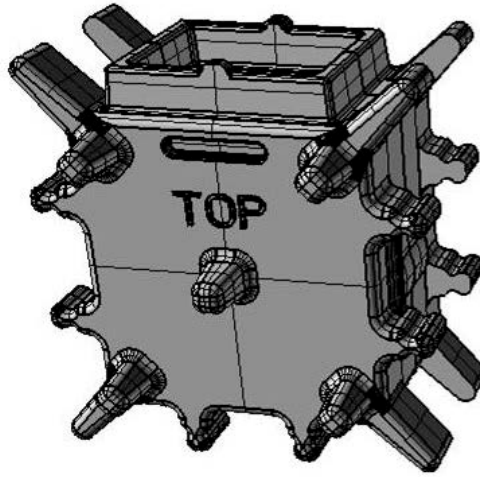
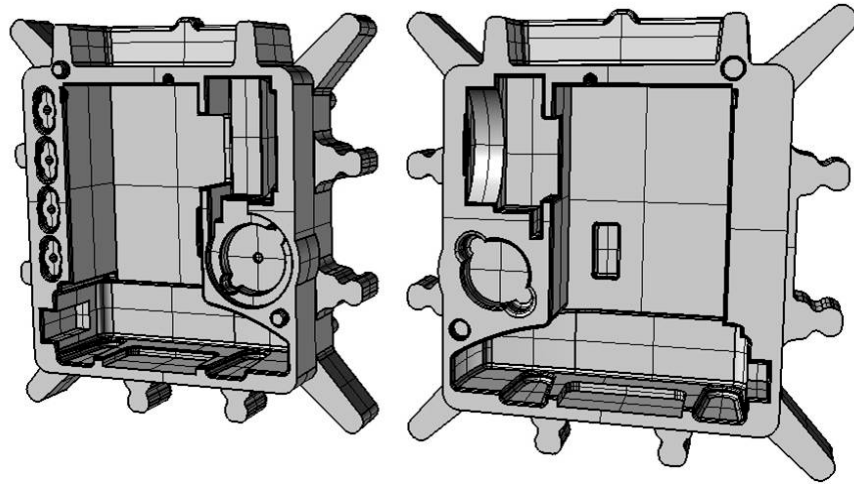

6 Unpacking, Setup and Commissioning

6.1 Installation Site, Location of Use

The balances are designed in a way that reliable weighing results are achieved in common conditions of use.

You will work accurately and fast, if you select the right location for your balance.

Therefore, observe the following for the installation site:

- Place the balance on a firm, level surface;
- Avoid extreme heat as well as temperature fluctuation caused by installing next to a radiator or in the direct sunlight;
- Protect the balance against direct draughts due to open windows and doors;
- Avoid jarring during weighing;
- Protect the balance against high humidity, vapours and dust;
- Do not expose the device to extreme dampness for longer periods of time. Non-permitted condensation (condensation of air humidity on the appliance) may occur if a cold appliance is taken to a considerably warmer environment. In this case, acclimatize the disconnected appliance for ca. 2 hours at room temperature.
- Avoid static charge of goods to be weighed or weighing container.

If electro-magnetic fields or static charge occur, or if the power supply is unstable major deviations on the display (incorrect weighing results) are possible. In that case, the location must be changed.

6.2 Unpacking and checking

Remove device and accessories carefully from packaging, remove packaging material and place device at the planned work place. Verify that there has been no damage and that all packing items are present.

Scope of delivery / serial accessories:

- Balance, see chap. 2
- Mains adapter
- Operating manual
- Protective cover
- Flush-mounted hook
- Transport locking device (models AEJ-C and PLJ-C)

6.3 Placing

⇒ Remove transportation lock (only models AEJ-C and PLJ-C)

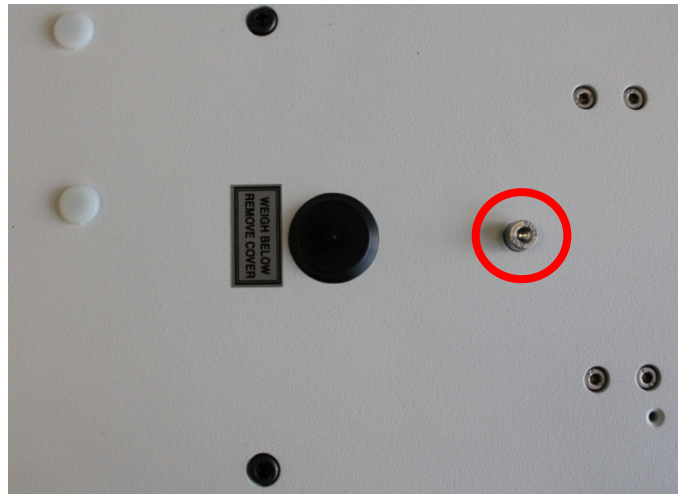

To detach transport locking device, unscrew locking screw.

For transportation screw in locking screw carefully right up to the limit stop.

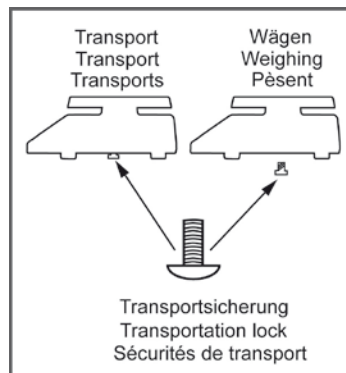

- Level balance with foot screws until the air bubble of the water balance is in the prescribed circle

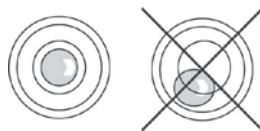

- Check levelling regularly

Models AEJ/AES-C

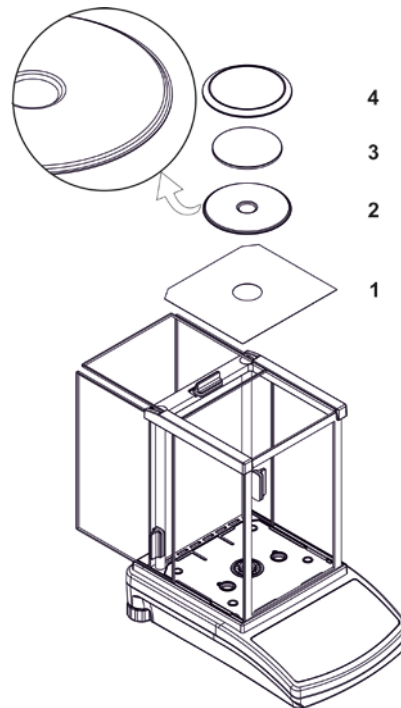

- Open glass wind screen on all sides
- Place protection sheet (1) into the weighing chamber
- Place centring ring (2) on the protection sheet
- Put weighing plate (3) on the centring ring
- Place wind protection ring (4) into the weighing chamber

Models PLJ-C:
10 mg models

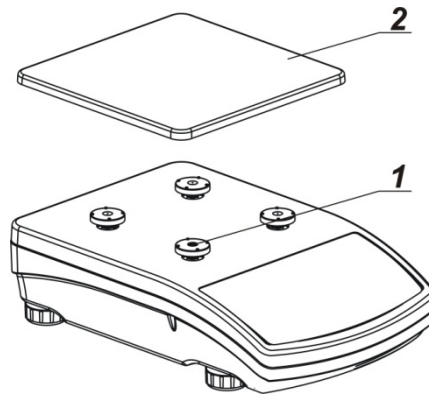

- Remove adhesive tape from the rubber element (1)
- Place weighing pan (2) on the rubber elements

1 mg models

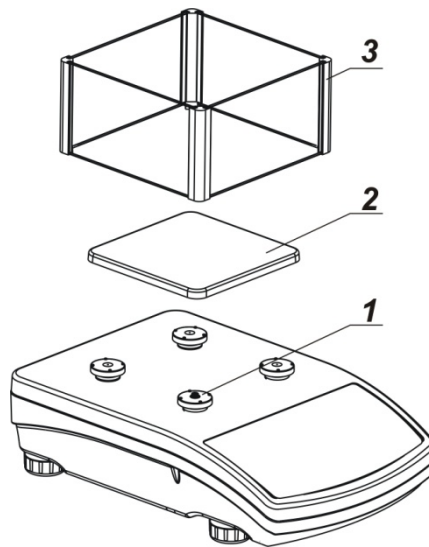

- Remove adhesive tape from the rubber element (1)
- Place weighing pan (2) on the rubber elements
- Place wind shield (3)

6.4 Mains connection

Power is supplied via the external mains adapter. The stated voltage value must be the same as the local voltage.

Only use original KERN mains adapters. Using other makes requires consent by KERN.

6.4.1 Turning On the Power

- Supply balance with power via the mains adapter. The display unit lights up and shown the software version. The weighing scale carries out a self-test and automatically moves into weighing mode.
When „CAL“ appears on the display, an automatic adjustment will take place (only models AEJ-C and PLJ-C).

6.5 Connection of peripheral devices

Before connecting or disconnecting of additional devices (printer, PC) to the data interface, always disconnect the balance from the power supply.

With your balance, only use accessories and peripheral devices by KERN, as they are ideally tuned to your balance.

6.6 Initial Commissioning

In order to obtain exact results with the electronic balances, your balance must have reached the operating temperature (see warming up time chap. 1).

During this warming up time the balance must be connected to the power supply (mains, accumulator or battery).

To adapt the balance to ambient conditions, open wind screen doors.

The accuracy of the balance depends on the local acceleration of gravity.

Strictly observe hints in chapter Adjustment.

7 Adjustment

As the acceleration value due to gravity is not the same at every location on earth, each balance must be coordinated - in compliance with the underlying physical weighing principle - to the existing acceleration due to gravity at its place of location (only if the balance has not already been adjusted to the location in the factory). This adjustment process must be carried out for the first commissioning, after each change of location as well as in case of fluctuating environment temperature. To receive accurate measuring values it is also recommended to adjust the balance periodically in weighing operation.

Possible adjustments include:

- Automatic adjustment by internal weight (models ILJ only)
Chap. 7.2.1
- Manual adjustment by internal weight is triggered by pressing **CAL**
- Adjustment with external weight, see chap. 7.2.2

i	<ul style="list-style-type: none">• Adjustment can only be carried out when the weighing pan is free of objects. Any loads remaining on the weighing pan will be indicated by error message Er1Hi.• You can cancel the adjustment by pressing the UNIT-key.
----------	---

7.1 Automatic adjustment with internal weight (only AEJ-C and PLJ-C)

With the internal adjustment weight, the weighing accuracy can be checked and re-adjusted at any time.

The automatic adjustment function is always enabled. You can start adjustment at any time by pressing the **CAL**-key manually.

If a load is present on the weighing plate, the message LIMIT EXCEEDED will appear on the display. If the weight on the weighing plate is below 10% of max, the weighing scale nevertheless will be adjusted.

Automatic adjustment is carried out:

- When balance was disconnected from the mains.
- When the temperature is changing
The moment a change in temperature of 3°C is detected by the temperature sensor, the weighing scale will carry out a fully automatic adjustment. The °C symbol indicates the pending adjustment.



- at the end of a time interval

After the time interval (selectable 1-12 h) specified in the menu has passed.



- i** In weighing scales with type approval certificate
- Adjustment takes place every 3 hours

- i** In the following operating modes the automatic internal adjustment is disabled:
- Parts counting
 - Tolerance weighing
 - Dosing
 - Percent determination
 - Animal weighing
 - Statistics
 - Totalization
 - Hold function

7.2 Menu settings

Menu item „P1 ADJUSTMENT“ [Adjustment]

AEJ-C / PLJ-C	AES-C	
P1.1 INT.JUST.	-	Internal adjustment, ILJ-C only
-	P1.2 EXT.JUST.	External adjustment *
-	P1.3 BE.JUST.	User adjustment
P1.4 TEST JUST.	-	Adjustment test

* = Locked in weighing scales with type approval certificate [Er 9 lock].

7.2.1 P1.1 INT.JUST. - internal adjustment (only models AEJ-C and PLJ-C)

- For automatic internal adjustment see chap. 7.1
- Starting internal adjustment manually

Press the **CAL**-key or invoke menu “P1.1 INT.JUST.”

Press  or

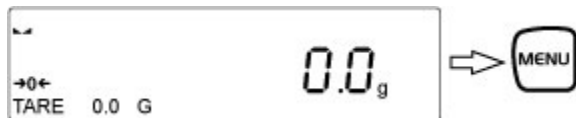

Internal adjustment will be taking place.



- Ensure that there are no objects on the weighing pan.
- You can cancel the adjustment by pressing the **UNIT**-key.
- After successful adjustment the weighing scale will return automatically to the menu item. To return to weighing mode, press **UNIT**.

7.2.2 P1.2 EXT.JUST.- external adjustment (only AES-C)

Carry out adjustment with the help of the recommended adjustment weight (see chapter 1 “Technical Specifications”).

Observe stable environmental conditions. A warming up time (see chapter 1) is required for stabilization.

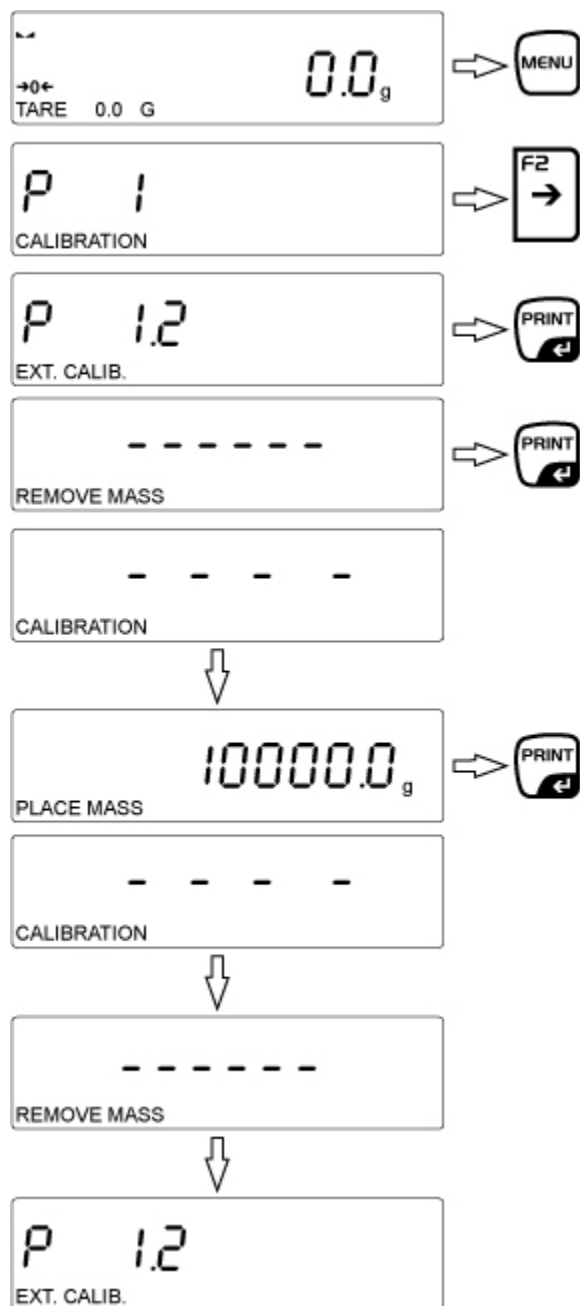

Ensure that there are no objects on the weighing pan. Press **PRINT**-key, **CALIBRATION** (JUSTAGE) will be shown.

Wait until the weighed value for the required adjustment weight appears. (Example)
Place the required adjustment weight carefully in the centre of the weighing plate and press the **PRINT** key.
The display is showing **CALIBRATION**, adjustment is starting.

Adjustment is completed when the message **REMOVE MASS** appears; remove adjustment weight. After successful adjustment the weighing scale will return automatically to sub-menu item **P 1.2**.

To return to weighing mode, press the **UNIT** key.



- This function is locked in weighing scales with type approval certificate.

7.2.3 P1.3 BE.JUST. User adjustment (model AES-C only)

This function allows the user to select a test weight of an arbitrary weight value.

Having said this, the test weight should not amount to less than 30% of the maximum range.

This function is not accessible in calibrated weighing scales!

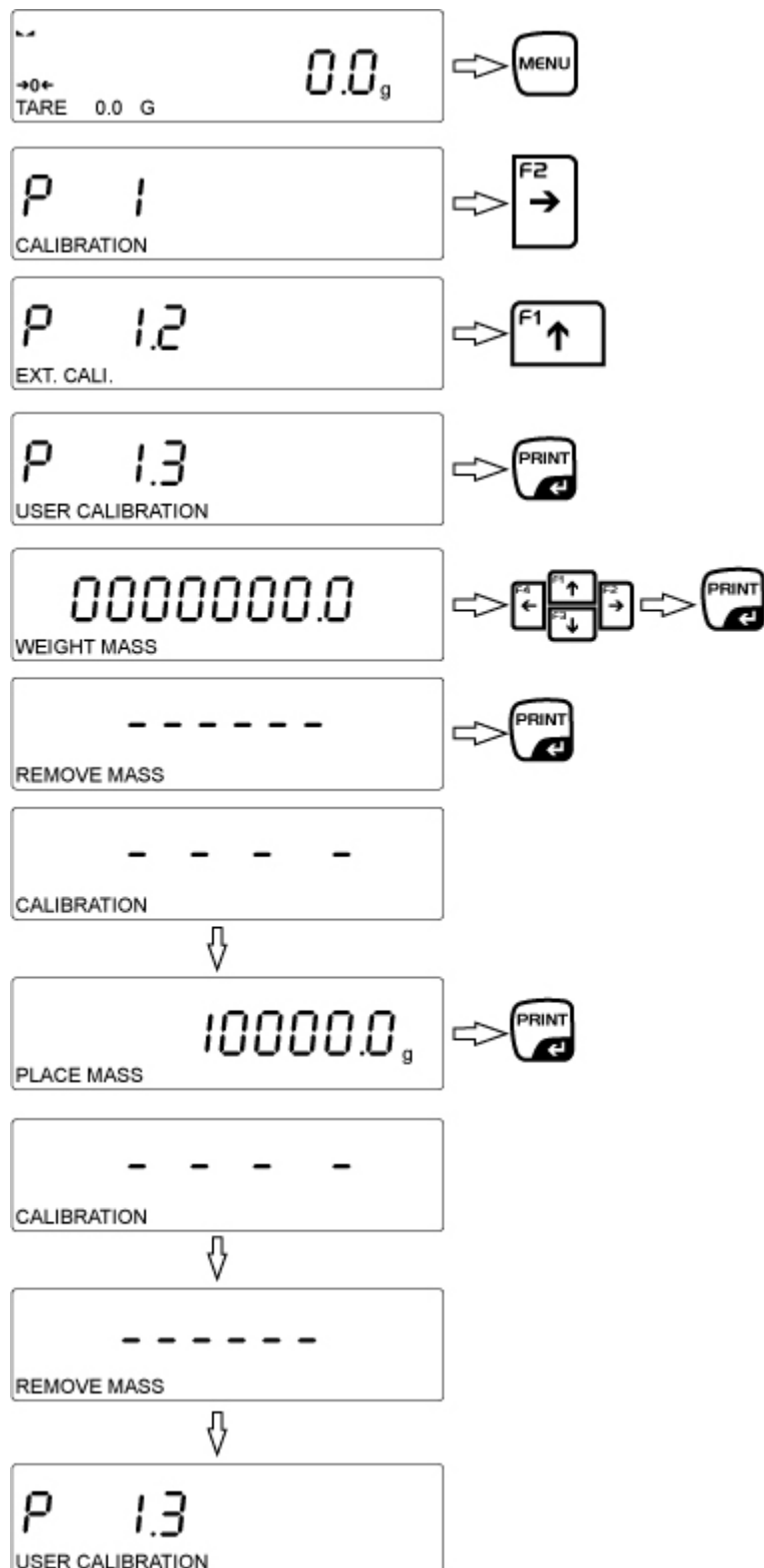

Start the process in weighing mode as shown on the picture.

Digits will appear on the display, with the digit on the left flashing. Use the arrow keys to enter your desired adjustment weight and confirm by pressing **PRINT**.

Care should be taken to ensure that there are no objects on the weighing plate, then confirm by pressing **PRINT**.

Wait until the weighed value for the set adjustment weight appears. Place the required adjustment weight carefully in the centre of the weighing plate and press the **PRINT** key. The display is showing **CALIBRATION**, adjustment is starting.

Adjustment is completed when the message **REMOVE MASS** appears; remove adjustment weight. After successful adjustment the weighing scale will automatically return to sub-menu item **P 1.3**.

Return to weighing mode by repeatedly pressing **UNIT**

7.2.4 P1.4 TEST JUST. – adjustment report (only models AEJ-C and PLJ-C)

This function is applied to compare the internal adjustment weight with the saved value. The test is carried out automatically. The result will be shown on the display and issued via the interface if an optional printer is connected.

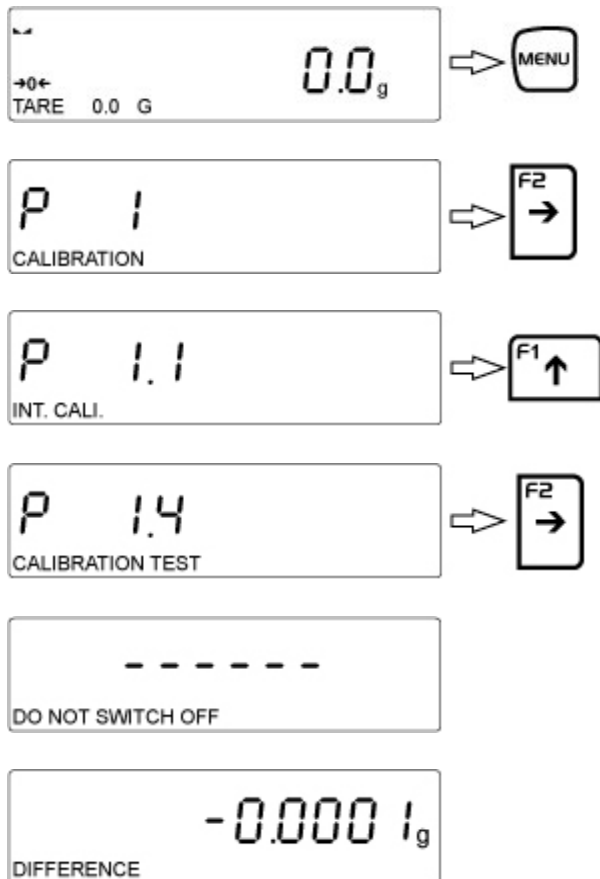

Press **UNIT** to return to the menu item and into weighing mode

7.2.5 Printing adjustment reports

An adjustment report will be generated automatically after an adjustment and sent to the RS232 connection COM 1.

For setting of adjustment report see chap. 17.1.1

Sample adjustment record:

-----Just.Prot.-----	
Art Adjust	External
User	Kern
Draft	
Datum	21.11.2013
Time	9:54:39
ID Balance	132051
Diff.Just.	-0.2 g

Signature	

7.3 Verification

General introduction:

According to EU directive 2009/23/EC balances must be officially verified if they are used as follows (legally controlled area):

- a) For commercial transactions if the price of goods is determined by weighing.
- b) For the production of medicines in pharmacies as well as for analyses in the medical and pharmaceutical laboratory.
- c) For official purposes
- d) For manufacturing final packages

In cases of doubt, please contact your local trade in standard.

Verification notes:

An EU type approval exists for balances described in their technical data as verifiable. If a balance is used where obligation to verify exists as described above, it must be verified and re-verified at regular intervals.

Re-verification of a balance is carried out according to the respective national regulations. The validity for verification of balances in Germany is e.g. 2 years.

The legal regulation of the country where the balance is used must be observed!



Verification of the balance is invalid without the seal.

The seal marks attached on balances with type approval point out that the balance may only be opened and serviced by trained and authorised specialist staff. If the seal mark is destroyed, verification loses its validity. Please observe all national laws and legal regulations. In Germany a re-verification will be necessary.

Position of the “official seals“:
Models PLJ-C

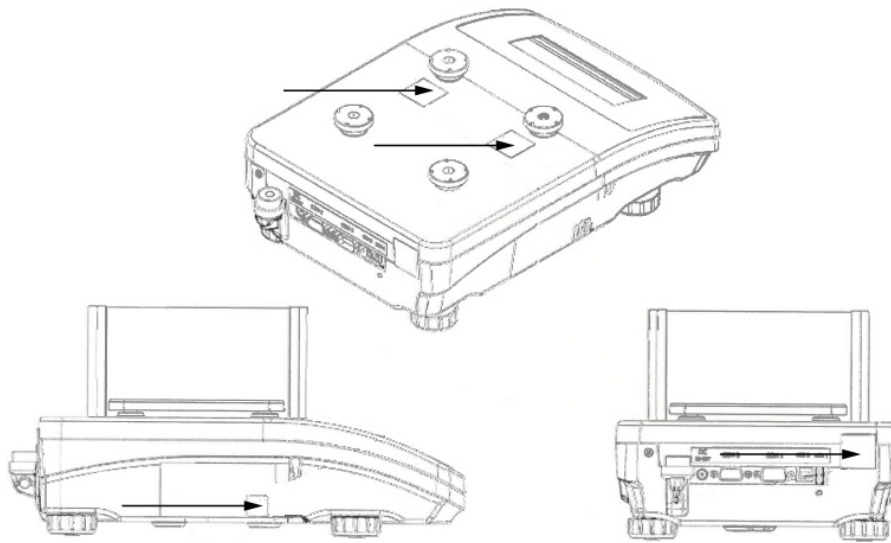

Models AEJ-C and AES-C

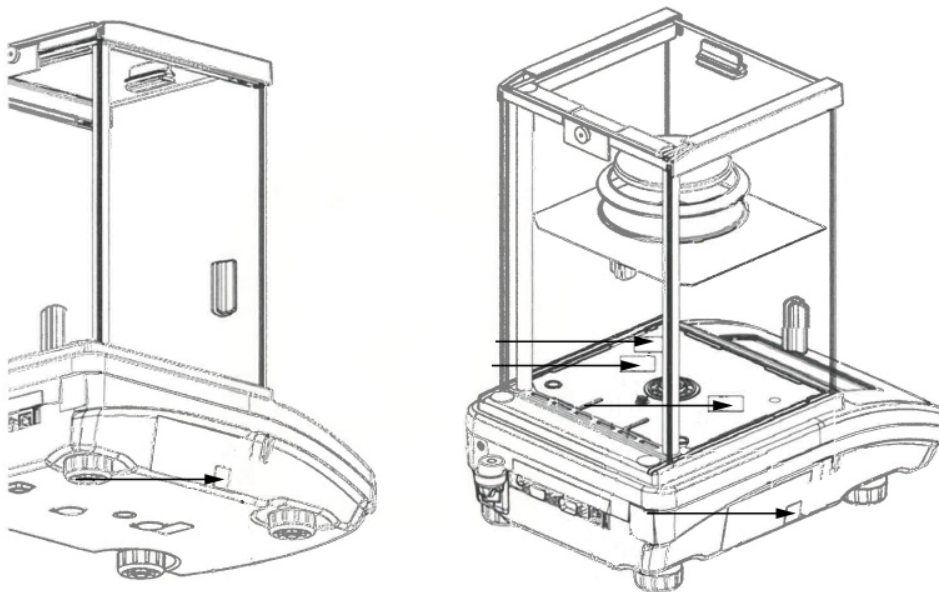

Balances with obligation to verify must be taken out of operation if:

- **The weighing result of the balance is outside the error limit.** Therefore, in regular intervals load balance with known test weight (ca. 1/3 of the max. load) and compare with displayed value.
- **The reverification deadline has been exceeded.**

8 Menu

8.1 Navigation in the menu

Call up menu	In weighing mode press the MENU -key and the first menu block "P1 CALIBRATION" will appear.
Select menu block	Use the cursor key ↑ to select the individual menu blocks one by one. Use the cursor key ↓ to scroll down. Use the cursor key ↑ to scroll up.
Select menu item	Confirm selected menu block by pressing → . The first menu item of the selected menu block will be shown. Use the cursor key ↑ to select individual menu items one by one. Use the cursor key ↓ to scroll down. Use the cursor key ↑ to scroll up.
Select setting	Confirm selected menu item with → and the current setting will be shown
Change settings	Use the navigation keys to switch over into the available settings. Use the cursor key ↓ to scroll down. Use the cursor key ↑ to scroll up.
Confirm setting / back to menu	Either confirm by pressing the PRINT -key or reject by pressing the UNIT -key.
Save / back to weighing mode	see chap. 8.3

8.2 Menu overview

The menu is subdivided into seven menu blocks (P1 – P7).

P1 CALIBRATION

P1.1	INT.CALIB.	[Internal adjustment] ILJ-C only
P1.2	EXT.CALIB.	[external adjustment] *
P1.3	USER CALIBRATION	[Entry adjustment weight]
P1.4	CALIBRATION TEST	[Adjustment test] ILJ-C only*
P1.5	AUT.CALIB.	[not documented]
P1.6	AU.TIME.JUST	[not documented]

* = locked in devices with type approval certificate

[Adjustment]

P2 WORKING MODE

P2.1	ACCESSIBILITY	[Operating modes] [Function selection]
	P2.1.1 WEIGHING YES/NO	
	P2.1.2 COUNTING PCS YES/NO	
	P2.1.3 CHECKWEIGHING YES/NO	
	P2.1.4 DOSING YES/NO	
	P2.1.5 DEVIATIONS YES/NO	
	P2.1.6 SOLIDS DENS. YES/NO	
	P2.1.7 LIQUID DENS YES/NO	
	P2.1.8 ANIMAL WEIGH. YES/NO	
	P2.1.9 STATISTICS YES/NO	
	P2.1.10 TOTALIZING YES/NO	
	P2.1.11 PEAK HOLD YES/NO	
P2.2	WEIGHING	[Weighing mode]
	P2.2.1 READING	
		P2.2.1.1 FILTER MEDIUM/SLOW/VERY.SLOW/VERY.FAST/FAST
		P2.2.1.2 ACK.RESULT FAST+ACCURATE/ACCURATE/FAST
		P2.2.1.3 AUTOZERO YES/NO
		P2.2.1.4 LASTDIGIT ALWAYS/NEVER/WHEN STABLE
		P2.2.1.5 ENVIRONMENT UNSTABLE/STABLE
	P2.2.2 AUTO TARE	
	P2.2.3 PRINT MOD.	
		P2.2.3.1 MODE EACH/WHEN STAB./AUTO/
		P2.2.2.2 AUTOTHRESH. 0.0
	P2.2.4 INFORM / BARGRAPH	
	P2.2.5 NSTD INF	
	P2.2.6 HOT KEYS	

P2.3	COUNTING PCS For sub-menus see menu item P2.2 Additional: P2.3.3 INFOM REF.WEIGHT P2.3.6 ACAI YES	[piece counting]
P2.4	CHECK WEIGHING For sub-menus see menu item P2.2.1	[Checkweighing]
P2.5	DOSING For sub-menus see menu item P2.2.1	[Dispensing]
P2.6	DEVIATIONS For sub-menus see menu item P2.2.1	[Determination of percentage]
P2.7	SOLIDS DENS For sub-menus see menu item P2.2.1	[Determination of density of solids, not recorded]
P2.8	LIQUID DENS For sub-menus see menu item P2.2.1	[Determination of density of liquids, not recorded]
P2.9	ANIMAL WEIGH. For sub-menus see menu item P2.2.1	[Animal weighing]
P2.10	STATISTICS For sub-menus see menu item P2.2.1	[Statistics function]
P2.11	TOTALISING For sub-menus see menu item P2.2.1	[Adding up function]
P2.12	PEAK HOLD P2.12.1 READING For sub-menus see menu item P2.2.1 P2.12.2 INFORM NET/GROSS/USER/PRODUCTS/SPECINFORM/NO/TARE P2.12.3 NSTD INF P2.12.4HOT KEYS P2.12.4.1 F1 PRINT HEADER F2 LOGIN F3 PRINT HEADER F4 SELECT PRODUCT P2.12.5. THRESHOLD 1.0	[Hold function]

P3 COMMUNICATION

[Interface parameter]

P3.1	COM 1 P3.1.1 BAUD RATE 4800/9600/19200/38400/57600/115200/2400 P3.1.2 PARITY NONE/PAIRED/UNPAIRED	[Transmission parameter COM 1]
P3.2	COM 2 For sub-menus see menu item P3.1	[Transmission parameter COM 2]
P3.3	WIFI P3.3.1 STATUS NONE P3.3.2 SELECT NET P3.3.3 NET-PAR. P3.3.3.1 NAME P3.3.3.2 PASSWORD P3.3.3.3 CHANNEL No. AUTO/1/2/...14 P3.3.3.4 IP 10.10.1.250 P3.3.3.5 MASK 255.255.0.0 P3.3.4 WI-FI	[not documented]

P4 DEVICES

[Connecting devices]

P4.1	COMPUTER	[Connection to computer]
	P4.1.1 PORT COM 1/COM 2/USB/WIFI/NONE	
P4.2	PRINTER	[Connection to printer]
	P4.2.1 PORT COM 1/COM 2/USB/WIFI/NONE	
P4.3	BARCODE READER	[not documented]
	P4.3.1 PORT NONE/COM 1/COM 2/NONE	
P4.4	ADD. DISPLAY	[not documented]
	P4.4.1 PORT COM 1/COM 2/NONE	
P4.5	EXT. BUTTONS	[not documented]

P5 PRINTOUTS

[Printer settings]

P5.1	CAL. REPORT	[Printout of adjustment report]
	P5.1.1 DRAFT _/0-9/A...Z	
P5.2	HEADER	[Printout of header]
	P5.2.1 DAHES	YES/NO
	P5.2.2 WORK. MODE	YES/NO
	P5.2.3 DATE	YES/NO
	P5.2.4 TIME	YES/NO
	P5.2.5 SCALETYPE	YES/NO
	P5.2.6 BALANCE ID	YES/NO
	P5.2.7 USER	YES/NO
	P5.2.8 PRODUCT	YES/NO
	P5.2.9 VARIABLE 1	YES/NO
	P5.2.10 VARIABLE 2	YES/NO
	P5.2.11 BLANK LINE	YES/NO
	P5.2.12 CAL. REP.	YES/NO
	P5.2.13 STANDARD PRINTOUT	NONE/SPECPRINT 1-4
P5.3	GLP PRNT	[Printer settings]
	P5.3.1 DATE	YES/NO
	P5.3.2 TIME	YES/NO
	P5.3.3 USER	YES/NO
	P5.3.4 PRODUCT	YES/NO
	P5.3.5 VARIABLE 1	YES/NO
	P5.3.6 VARIABLE 2	YES/NO
	P5.3.7 NET	YES/NO
	P5.3.8 TARE	YES/NO
	P5.3.9 GROSS	YES/NO
	P5.3.10 CURR.RESULT	YES/NO
	P5.3.10 CAL. REPORT	YES/NO
	P5.3.11 STANDARD PRINTOUT	NONE/SPECPRINT 1-4

P5.4	FOOTER	[Printout of footer]
	P5.4.1 WORK. MODE	YES/NO
	P5.4.2 DATE	YES/NO
	P5.4.3 TIME	YES/NO
	P5.4.4 SCALE TYPE	YES/NO
	P5.4.5 BALANCE ID	YES/NO
	P5.4.6 USER	YES/NO
	P5.4.7 PRODUCT	YES/NO
	P5.4.8 VARIABLE 1	YES/NO
	P5.4.9 VARIABLE 2	YES/NO
	P5.4.10 DASHES	YES/NO
	P5.4.11 BLANK LINE	YES/NO
	P5.4.12 CAL. REPORT	YES/NO
	P5.4.13 SIGNATURE	YES/NO
	P5.4.14 STANDARD PRINTOUT	NONE/SPECPRINT 1-4
P5.5	NSD. PRN. 1	[Special printout no.2]
P5.6	NSD. PRN. 2	[Special printout no.2]
P5.7	NSD. PRN. 3	[Special printout no.3]
P5.8	NSD. PRN. 4	[Special printout no.4]
P5.9	VARIABLE 1	[Printout Variable 1]
P5.10	VARIABLE 2	[Printout Variable 2]

P6 OTHER

[additional useful functions]

P6.1	LANGUAGE GERMAN	[Select menu language English/Deutsch/Espanol/Francais/Turk/Cesky/Italiano/Magyar/Polски]
P6.2	ACCESS LEV ADMIN	[Access steps for editing menu]
P6.3	KEY SOUND YES	[Keypad tone on/off]
P6.4	BACKLIGHT 70	[Background illumination]
P6.5	STAND-BY MODE	[Standby adjustable]
P6.6	AUTO SWITCH OFF	[Auto Off after x minutes]
P6.7	DATE 06.11.2013	[Setting date]
P6.8	TIME 12:30:04	[Setting time]
P6.9	DATE-FORM DDMMYYYY	[Date format]
P6.10	TIME-FORM	[Time format]
P6.11	GLP AUTOTEST	[Automatic printout of the GLP after finished weighing]

P7 INFO

P7.1 BALANCE ID 123456
P7.2 SCALE TYPE
P7.3 SOFT.VER.
P7.4 TEMP. 25.3 °C
P7.5 SETUP PRNT.

[Balance settings]

[Balance ID]
[Balance model]
[Software status]
[Temperature]
[Printer settings]

P8 UNITS

P8.1 ACCESSABILITY
P8.2 START UNIT
P8.3 USER UNIT 1.
P8.4 USER UNIT 2.

[Weighing units]

[Function selection]
[Determine standard unit]
[Determine user-defined unit 1]
[Determine user-defined unit 2]



Some settings are identical in every particular but there are additional specific settings for each menu item.

8.3 Exit menu / back to weighing mode.

- ⇒ Any changes carried out are stored by pressing the **PRINT** key.
To cancel changes, press the **UNIT-ESC**-key.
- ⇒ Then the balance returns automatically into the weighing mode.

9 Entry by navigation keys

Input via cursor keys

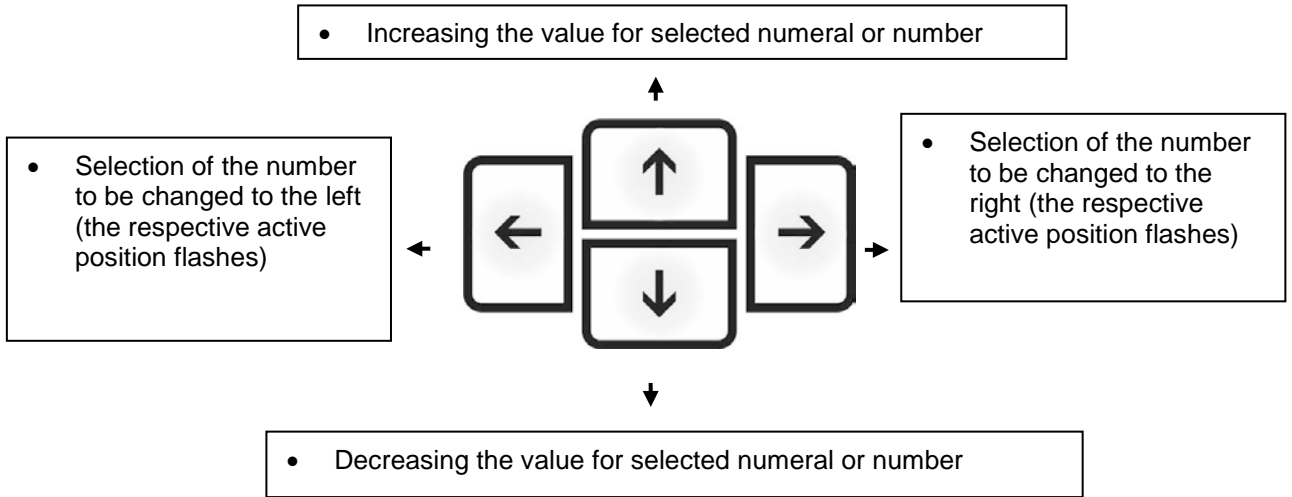

Overview data input / data output:

0	1	2	3	4	5	6	7	8	9
0	1	2	3	4	5	6	7	8	9
A	B	C	D	E	F	G	H	I	J
A	B	C	D	E	F	G	H	I	J
K	L	M	N	O	P	Q	R	S	T
K	L	M	N	O	P	Q	R	S	T
U	V	W	X	Y	Z				
U	V	W	X	Y	Z				

Example:

Data input	Data output
<i>OPLWILK</i>	OP1_WILK

10 User

To access all user parameters and data bases, the user must be logged-in as ADMINISTRATOR. The password for the administrator is **1111**. This setting was preset by the factory. Login is not required.

The software allows you to create 10 users with different authorisations.

10.1 Login/logout

Login:

- Select weighing mode and press the **DATA**-key. "b1 USER" will be displayed.
- Confirm by pressing **PRINT** and press **↑** to select "ADMIN"; confirm by pressing **PRINT**.
- Use the arrow keys for entering the admin password "**1111**", and confirm by pressing **PRINT**.

When logging in next time, select respective user and enter password. The weighing scale starts operation according to the authorisations of the selected user.

Logout:

- Select user and confirm "NO" by pressing **PRINT**.
- The balance returns automatically into weighing mode.

For creating new users and allocating authorisations, see chap. 18.1.

10.2 Authorisation levels

The software of the weighing scale operates on three authorisation levels.

- ADMINISTRATOR
- ADVANCED USER
- USER

i	Weighing is accessible at any time after weighing scale start-up.
----------	---

Authorisations	Authorisation levels
USER	Access to editing of parameters <ul style="list-style-type: none"> ⇒ Sub-menu P2.2.1 READING ⇒ Main menu P6 OTHER (apart from DATE and TIME) The user is entitled to: <ul style="list-style-type: none"> ⇒ Carry out all weighing processes ⇒ Have access to view information in the data base ⇒ Define variables
Add new users and delete existing users, see chap. 18.1	
ADVANCED USER	Access to editing of parameters <ul style="list-style-type: none"> ⇒ Sub-menu P2.2.1 READING ⇒ Sub-menu FUNCTIONS ⇒ Main menu P3 COMMUNICATION ⇒ Main menu P4 DEVICES ⇒ Main menu P6 OTHER (apart from DATE and TIME) The user is entitled to: <ul style="list-style-type: none"> ⇒ Carry out all weighing processes
ADMINISTRATOR	Access to all user parameters, functions and to editing of data bases

Authorisations are set in menu chap. 8 under menu item P6.2 (See chap 18.1).

11 Weighing

11.1 Switch on-off balance

- The weighing scale will carry out a self-test after having been connected to the power supply and will then automatically go into weighing mode.



- To turn off press the **ON/OFF**-key; time will be displayed. The balance is now in stand-by mode. No warming-up time is required and it will be ready for operation immediately after switching on (Press **ON/OFF**-key).
- To switch-off the balance completely, separate balance from power supply.

11.2 Weighing



For warm-up time required for stabilisation (see chap. 1)

- ⇒ Check zero display [→0←] and set to zero with the help of the **TARE** key, as required.
- ⇒ Place goods to be weighed on balance.
- ⇒ Wait until the stability display appears (▢).
- ⇒ Read weighing result

When an optional printer is connected, the weighing value can be edited.

11.3 Weighing units switch-over

The weighing unit selected here remains even after disconnection from the mains.

- Press **UNIT** repeatedly until the desired weighing unit is displayed.

To enable or disable individual units go to the menu (See chap. 9.1 menu overview)

For setting options see chap. 12.7

	Weighing scales with type approval options are restricted to [g] → [kg] → [ct] .
---	---

11.4 Taring

The dead weight of any weighing container may be tared away by pressing a button, so that the following weighing procedures show the net weight of the goods to be weighed.

- ⇒ Put vessel of goods to be weighed on weighing plate and close the wind screen doors.
- ⇒ Wait until the stability display appears (☐), then press **TARE**. The weight of the container is now internally saved.
- ⇒ Weigh the goods to be weighed and close the wind screen doors.
- ⇒ Wait until the stability display appears (☐).
- ⇒ Read net weight.
 - When the balance is unloaded the saved taring value is displayed with negative sign.
 - To delete the stored tare value, remove load from weighing pan and press **TARE**.
 - The taring process can be repeated any number of times. The limit is reached when the whole weighing range is exhausted.

11.4.1 Entering a tare value manually (pre-tare)

- ⇒ In weighing mode press **F** button
- ⇒ Press **↑** to select setting ENTER TARE and confirm by pressing **PRINT**.
- ⇒ Use the arrow keys for entering the tare value and confirm by pressing **PRINT**.
- ⇒ The entered tare value will be displayed with a “-“

11.4.2 Deleting the tare value

To delete the tare value, press the TARE-key or enter value “0.000“.

11.5 Underfloor weighing

Objects unsuitable for placing on the weighing scale due to size or shape may be weighed with the help of the flush-mounted platform.

Proceed as follows:

- Switch off the balance.
- Open closing cover at the balance bottom.
- Screw in hook for under-floor weighing **carefully and completely**, see fig. 1.
- Place weighing balance over an opening.
- Attach load to hook and carry out weighing procedure.

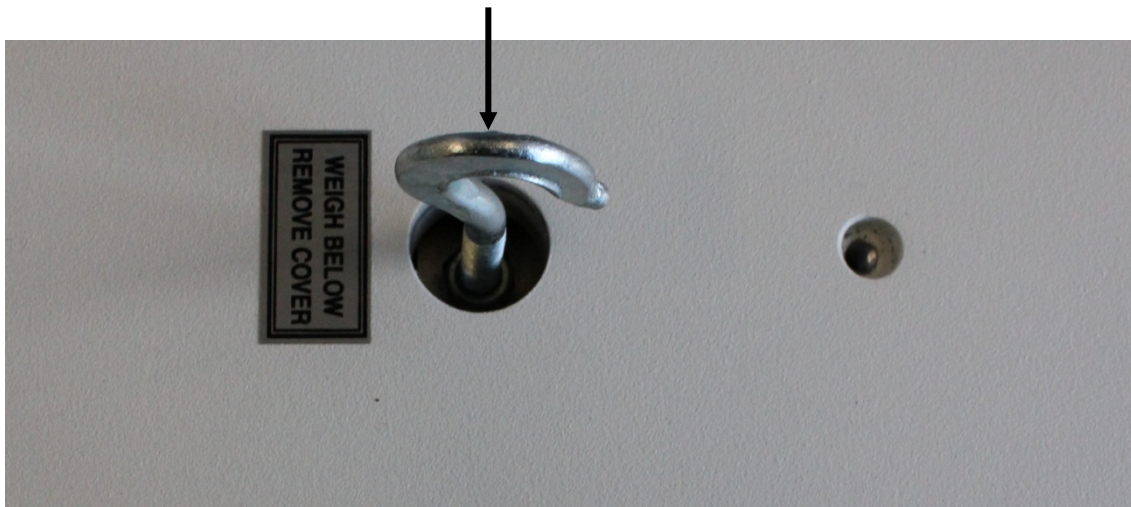

Fig.1: Setup of balance for underfloor weighing



CAUTION

- Always ensure that all suspended objects are stable enough to hold the desired goods to be weighed safely (danger of breaking).
- Never suspend loads that exceed the stated maximum load (max) (danger of breaking)
- Always ensure that there are **no persons, animals or objects** that might be damaged underneath the load.



After completing the underfloor weighing the opening on the bottom of the balance must always be closed (dust protection).

11.6 Selecting the operating mode

To enter individual operating modes, go to the “**P2 OPERATING MODULES**“ menu (see chap. 8 Menu).

11.6.1 Invoking operating modes:



Press the **MODE**-key and the name of the first available operating mode will be displayed.



Weighing mode

To go to other functions press **↑** or **↓**.



Piece counting (example)

Select desired function by pressing **→**.

Select additional functions in the same way (See chap. 8 menu – P2 operating modes).

11.6.2 To select operating modes:

To enable operating modes that are available to the user without having to go to the menu every time. Afterwards all enabled operating modes are available for invoking via **MODE**.

For this proceed as follows:

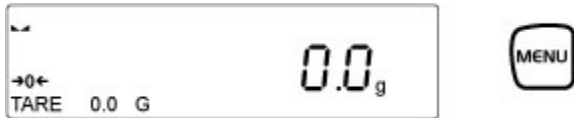

Use the arrow keys to select operating modes.



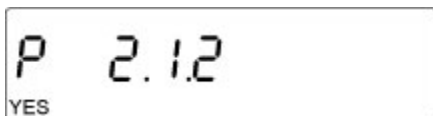

(example)



YES will be flashing

(example)

Either confirm with  or with  go to NO and then acknowledge with .

Please repeat this sequence of operations for any other operating mode available.

Press  3x and the scales will return to weighing mode.

12 Weighing scale settings operating mode weighing

This menu block can be used to adapt the behaviour of the weighing scale to your requirements (such as ambient conditions, special weighing procedures) **for any operating mode.**

i	Available settings for instance under menu item P2.2 WEIGHING
----------	---

12.1 Filter - adaptation to ambient conditions and weighing options

Set the filter according to operating conditions for the weighing scale.

Filter setting	Balance
MEDIUM	Normal ambient conditions
SLOW – VERY SLOW	The balance reacts slowly and in a robust manner - busy set-up location
FAST – VERY FAST	Weighing scale reacts sensitively and fast - Quiet place of installation



Example: Menu item P2.2.1 invoke READING, press

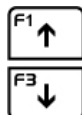
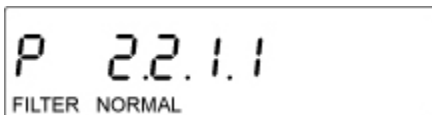
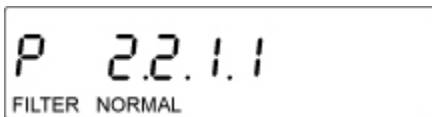

NORMAL will be flashing; change between settings, using the arrow keys

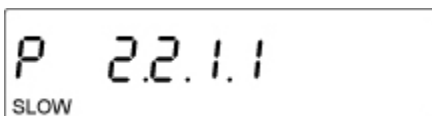

Save your selected setting by pressing **PRINT**

(example)

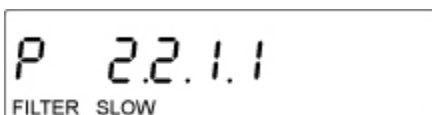

You have successfully saved your filter setting and the weighing scale will return to menu.

To return to weighing mode, press **UNIT** repeatedly.



12.2 Rest position control Adaptation of weighing speed

Example: Menu item P2.2.1 invoke READING, press

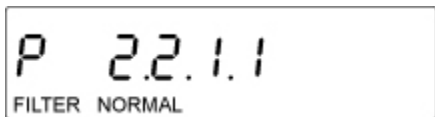

ACK.RESULT FAST+ACCURATE will be displayed

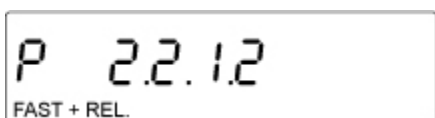

(example)

FAST+ACCURATE will be flashing.

- FAST + ACCURATE: Quiet place of installation
- ACCURATE: Noisy place of installation
- FAST: very quiet site



Use the arrow keys to select your desired setting

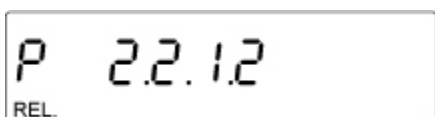

(example)



Save your selected setting by pressing **PRINT**



The setting is saved in such a way that the weighing scale returns to the menu. To return to weighing mode, press **UNIT** repeatedly.



12.3 Auto Zero

This function is used to tare small variations in weight automatically. In the event that small quantities are removed or added to the material to be weighed, incorrect weighing results can be displayed due to the “stability compensation”. (e.g. slow flow of liquids from a container placed on the balance, evaporating processes).

When apportioning involves small variations of weight, it is advisable to switch off this function.



Example: Menu item P2.2.1 invoke READING, press

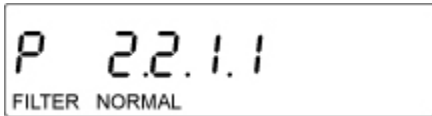

2x



AUTOZERO YES will be displayed

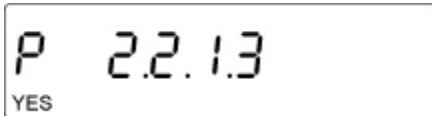

YES will be flashing

Use the arrow keys to change between YES and NO



YES – Auto zero enabled

NO – Auto zero disabled

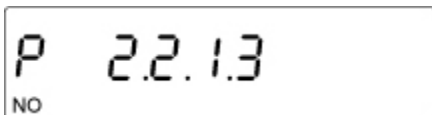

To save desired setting, press **PRINT**

(example)

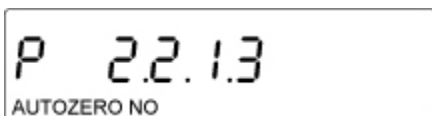

The setting is saved in such a way that the weighing scale returns to the menu.

To return to weighing mode, press **UNIT** repeatedly.



12.4 Hide last decimal place

Readability may be reduced by 1 digit on the weighing balances, as required. The last decimal place will be rounded and removed from the display.

Example: Menu item P2.2.1 invoke READING, press 

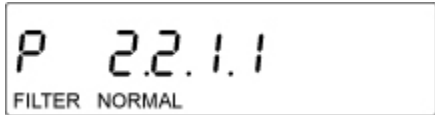

4x



LAST DIGIT ALWAYS is displayed

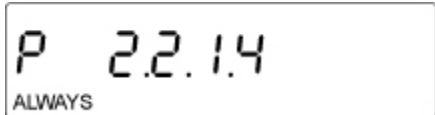

ALWAYS will be flashing
Use the arrow keys to change between ALWAYS, NEVER and IF STABLE.



- ALWAYS – last decimal place is displayed
- NEVER – last decimal place is hidden
- IF STABLE – last decimal place is only displayed for stable weighing values.

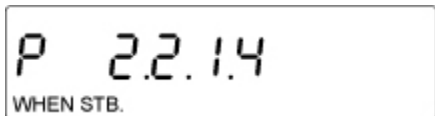

(example)



To save desired setting, press **PRINT**



The setting is saved in such a way that the weighing scale returns to the menu.
To return to weighing mode, press **UNIT** repeatedly.



12.5 Environmental conditions

This menu item allows you to adjust the weighing scale to its ambient conditions. You have the option of selecting between STABLE and UNSTABLE ambient conditions.

Example: Menu item P2.2.1 invoke READING, press 

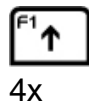
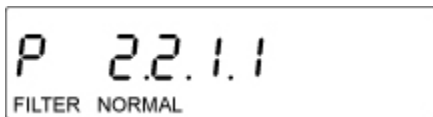

ENVIRON:UNSTABLE will be displayed

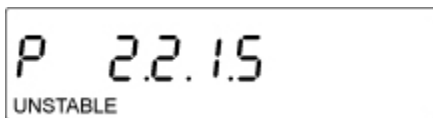

UNSTABLE will be flashing
Use the arrow keys to change between UNSTABLE and STABLE.

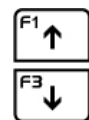

- UNSTABLE – difficult ambient conditions (vibrations, etc.)
- STABLE – normal ambient conditions

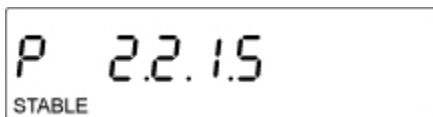

(example)



To save desired setting, press **PRINT**

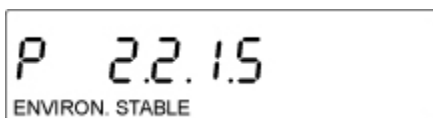

The setting is saved in such a way that the weighing scale returns to the menu.
To return to weighing mode, press **UNIT** repeatedly.



12.6 Print mode

This menu item is used to specify print settings:

- P2.2.2.1 Weighing scale printing:
- EACH: For all users
 - IF STABLE: When weighing scale is stable
 - AUTO: Automatically when weighing scale is stable

- P2.2.2.2 Weighing scale printing:
- AUTOTHRESH: The moment the threshold value is exceeded.
- How to enter a threshold value:
Invoke P2.2.2.2, press **F2** and you can enter the threshold value, using the arrow keys. Confirm with **PRINT**.

Invoke menu item P2.2.2, go to PRINTOUT MODE, press

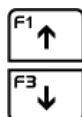
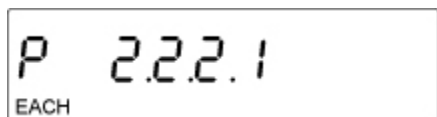
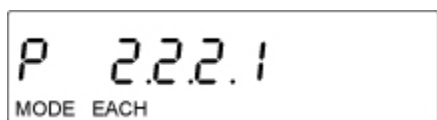

EACH will be flashing.
Use the arrow keys to select your desired setting

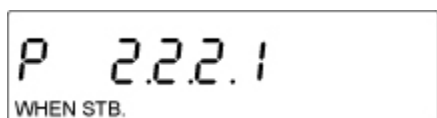

Confirm with **PRINT**

(example)

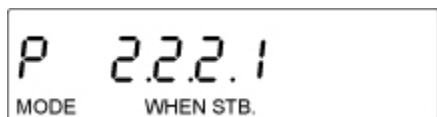

You have successfully saved this setting.
To return to weighing mode, press **UNIT**.



12.7 Information display

This function allows the display of additional information on the line at the lower margin of the display.

Items of information available for display include:

- BARGRAF
- TARE
- NET
- GROSS
- USER
- PRODUCT
- SPECINFORM
- NONE



INFORM TARE is displayed

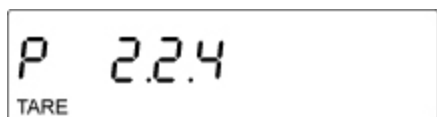

TARE is flashing

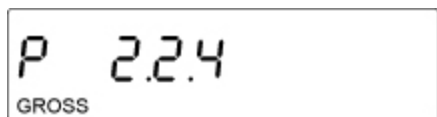

(example)



To change between the individual items of information use the arrow keys.

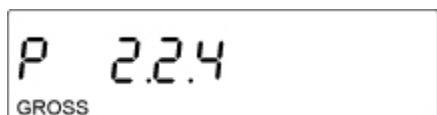

To save desired setting, press **PRINT**



The setting is saved in such a way that the weighing scale returns to the menu. To return to weighing mode, press **UNIT** repeatedly.



The information display shows GROSS.

12.7.1 Special information

This function allows the user to display arbitrary text of up to 19 lines.

First select the setting **SPECIAL INFORMATION** as follows:

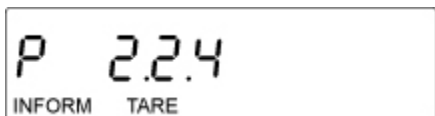

INFORM TARE is displayed

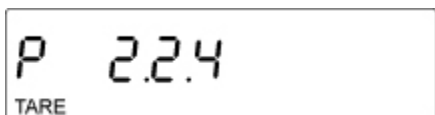

TARE is flashing
Use **↑** to scroll to NSTD.INF.
Confirm with **PRINT**.



You have selected the setting NSTD.INF.
To return to weighing mode, press **UNIT** repeatedly.

Enter the text for your **SPECIAL INFORMATION**:

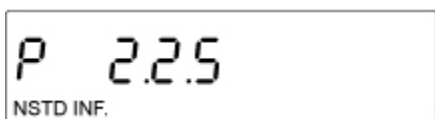

Select menu item NSTD INF.



The first character is flashing; use the arrow keys to enter your text.

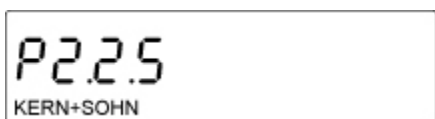

Confirm with **PRINT**.

(example)

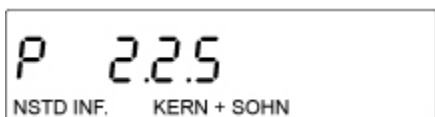

The entered text will be displayed as special information.
Press **UNIT** repeatedly until the balance is in weighing mode.



The entered text will be displayed on the information line.

12.7.2 Shortcut keys

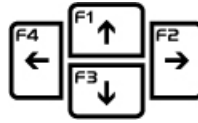

You can allocate functions to the 4 **F**-keys so as to have access to these functions by merely pressing these keys.

The following functions of operating mode WEIGHING are suitable for allocation: PRINT HEADER / PRINT FOOTER / VARIABLE 1 and 2 / NO / SELECT PRODUCT / LOGIN / ENTER TARE / SELECT TARE

Allocating function to respective key:

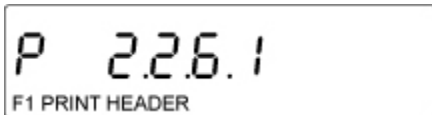
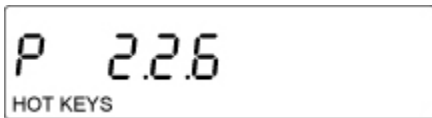

F1 PRINT HEADER appears
F1-key is allocated a function

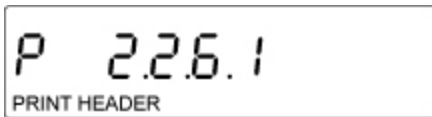

PRINT HEADER is flashing
Use the arrow keys to select the desired function

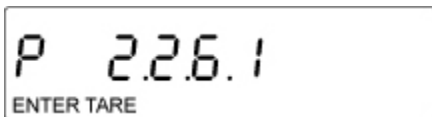

To save desired setting, press **PRINT**

(example)



This function is now allocated to the **F1**-key.
To return to weighing mode, press **UNIT** repeatedly.



If the F1-key is pressed in weighing mode, the set function will appear.



13 Additional operating modes

Menu item **P2 OPERATING MODULES**

The weighing scale offers the following operating modes:

Weighing, see chap. 11
Parts counting
Checkweighing
Dosing
Deviation (determination of percentage)
Density determination of solids
Determining density of liquids
Animal weighing
Statistics function
Totalization
HOLD function

Chapter 11.6 first describes how to enable the desired operating modes.

13.1 Parts counting

Before the balance can count parts, it must know the average part weight (i.e. reference). Proceed by putting on a certain number of the parts to be counted. The balance determines the total weight and divides it by the number of parts (the so-called reference quantity). Counting is then carried out on the basis of the calculated average piece weight.

As a rule:

The higher the reference quantity the higher the counting exactness.

- **Set operating mode PIECE COUNTING**

The ENTER REFERENCE WEIGHT function is allocated to the **F1**-key.

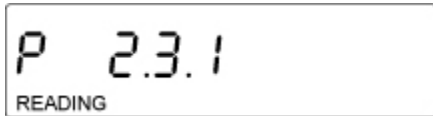

4x

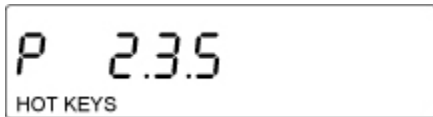

The previous setting will be displayed.

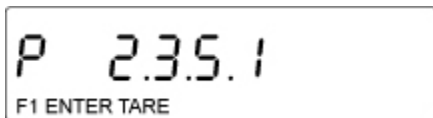

The previous setting for the **F1**-key will be flashing.

(example)

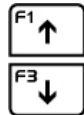
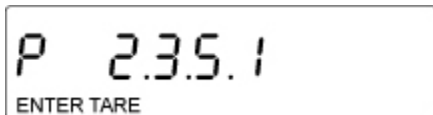

Use the arrow keys to select ENTER REFERENCE WEIGHT.

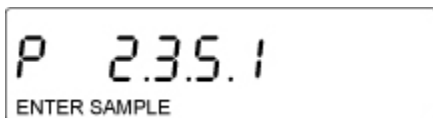

This completes the allocation of the function used to enter the reference weight to the **F1**-key.



In **piece counting mode** this enables you to invoke the function used to enter the reference weight by pressing **F1**.

- **Selecting piece counting mode and entering reference weight**



If this is the first time that a reference weight is entered 0 will be displayed.

If a reference weight was entered at an earlier date, the previous entry will be displayed.

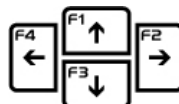

Use the arrow keys to enter the desired reference weight.



(example)



You have successfully entered a reference weight and piece counting can be started.

- **Return to weighing mode**

Press **MODE** and F1 WEIGHING will be displayed. Confirm by pressing **PRINT** and the weighing scale will change to weighing mode.

- **Determining reference weight by weighing**

The function DETERMINE REFERENCE WEIGHT is allocated to the **F2**-key.

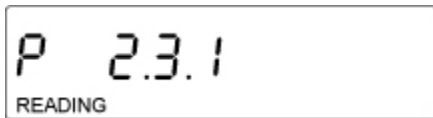
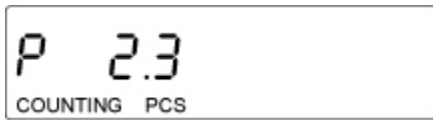

4x

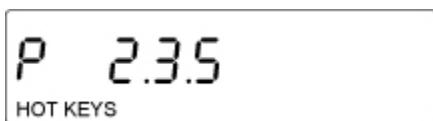

The previous setting will be displayed.



The setting is flashing. Press **F2** to make entries for the **F2**-key

(example)



The previous setting for the **F2**-key will be flashing.

(example)

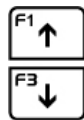
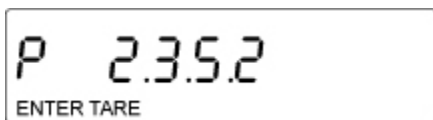

Use the arrow keys to select DETERMINE REFERENCE WEIGHT.



This completes the allocation of the function used to determine the reference weight by weighing to the **F2**-key.

In **piece counting mode** this enables you to invoke the function used to determine the reference weight by pressing **F2**.

- **Selecting reference quantity**

First go to the menu and select the setting **ACAI**:

P2.3 – Select QUANTITY, press **F2**, P2.3.1 – READING will be displayed;

Repeatedly press F2 until ACAI YES is displayed.

If NO is displayed: Press F2 and use the arrow keys to set YES, then confirm by pressing **PRINT**.



The last selected setting will be shown.



Place the reference weight on the pan and confirm by pressing **PRINT**.



The weight as well as the number of pieces matching this weight will be displayed.

Remove reference weight. The balance is now in parts counting mode and counts all units on the weighing plate.

13.2 Weighing with tolerance range

For weighing with tolerance ranges you can enter individual upper and lower limits. For tolerance controls such as dosaging, apportioning or sorting the scale will display violated upper or lower limits and show the tolerance tag.

The symbol in the upper part of the display shows whether the load is within the two tolerance limits.

The tolerance marker is only in operation during operating mode tolerance weighing; it is otherwise not visible.

The tolerance marker provides the following information:

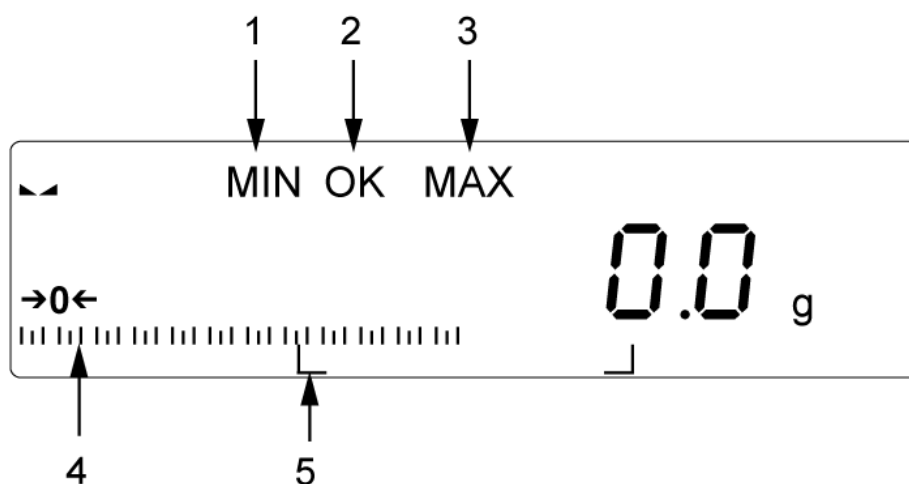

- 1 Goods to be weighed below tolerance limit
- 2 Goods to be weighed within tolerance range
- 3 Goods to be weighed above tolerance limit
- 4 Bar graph
- 5 Tolerance display



Thereby Bar graph and Tolerance display appear, set in the menu menu point **P2.2.4 INFORM** to **BARGRAF**.

The ENTER THRESHOLD function is allocated to the **F3**-key.

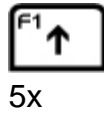
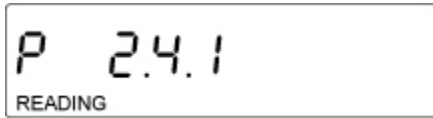

5x



P2.4.6.1 will be displayed showing the previous setting entered for the **F1**-key.

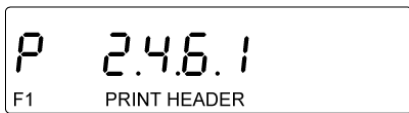

Press **F1** to select **F3**.

2x

(example)



The settings to be selected will be flashing. Use the arrow keys to select SET HI_LOW.

(example)



Confirm with **PRINT**.



This completes the allocation to the **F3** button of the SET HI_LOW function for checkweighing.

In **checkweighing mode** this allows you to invoke the function used to enter limits by pressing **F3**.

- **Enter limits**

Set the weighing mode for operating mode checkweighing as follows:



2X



You have set the operating mode checkweighing.



The symbols for the limits are displayed at the upper margin of the display.

At the lower margin the bar graph, and between two brackets the tolerance range is displayed.

Entering limits:



The display for entering the lower limit value will appear. MIN is displayed at the bottom left. The left digit will be flashing.

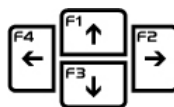

Use the arrow keys to enter the lower limit.

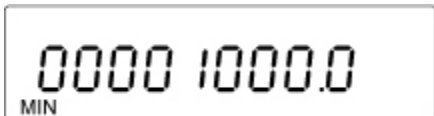

The lower limit value is thus entered.

The display changes to the prompt for entering the upper limit value.

(example)



Both limits have now been entered; the display changes to checkweighing mode.



In the information strip the tolerance range is displayed. The MIN symbol will appear at the upper margin of the display as 0 is the point from which values drop below the lower limit.

The weighing scale is ready now for checkweighing. Use the symbols MIN-OK-MAX, the bar graph and the tolerance display to check whether the load is within, above or below the intended tolerance.



If invalid values are entered such as lower tolerance limit greater than upper tolerance limit, the balance will issue the error message and return automatically to weighing mode.

• Return to weighing mode

Press **MODE** and F1 WEIGHING will be displayed. Confirm by pressing **PRINT** and the weighing scale will change to weighing mode.

13.3 Dosing

If dosing mode is enabled, the weighing scale will work at increased display speed. Please keep in mind that the weighing scale reacts very sensitively to ambient conditions.

Enter the target weight (reference weight) along with the tolerance:
The ENTER REFERENCE WEIGHT function is allocated to the **F4**-key.

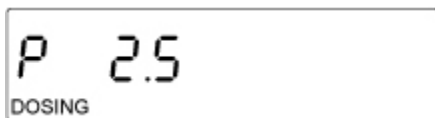

Select dosing mode

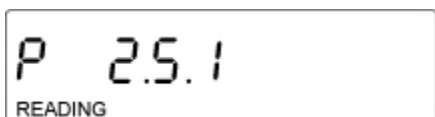

4x



P2.5.5.1 will be displayed showing the previous setting for the **F1**-key.

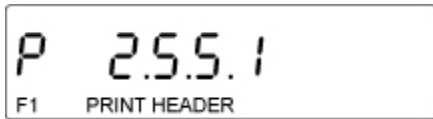

Press **F1** to select **F4**.

3x

(example)



The settings to be selected will be flashing. Use the arrow keys to select **ENTER SAMPLE**.

(example)

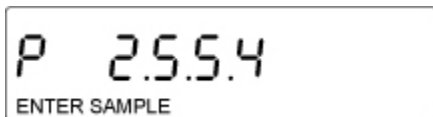

Confirm with **PRINT**.



Now the function **ENTER SAMPLE** for dosing is allocated to the **F4** button.

In **dosing mode** this allows you to enter the target weight along with the corresponding tolerance by pressing **F4**.

- **Enter target weight**

Setting weighing mode in operating mode dosing:



Operating mode dosing has now been set.



The symbol for dosing will be displayed at the upper margin of the display.

The setting **SAMPLE 0.0** will be displayed at the lower margin.

Entering target weight:



The display used to enter the target weight appears with the left digit flashing.

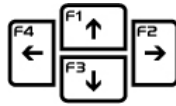

Use the arrow keys to enter the target weight and confirm by pressing **PRINT**.



The display used to enter the tolerance appears. Enter tolerance and confirm by pressing **PRINT**.



(example)

The target weight is displayed on the information line. The symbol for dosing and the MIN symbol will appear at the upper margin as no load has is present on the weighing plate. The target weight is displayed as negative value.

	Weight smaller than target weight
	Weight within tolerance
	Weight greater than target weight

- **Return to weighing mode**

Press **MODE** and F1 WEIGHING will be displayed. Confirm by pressing **PRINT** and the weighing scale will change to weighing mode.

13.4 Percent determination

Percent determination allows weight display in percent, in relation to a reference weight. The reference weight may be determined by weighing or by entering it numerically.

- **Determining reference by weighing**

The function DETERMINE REFERENCE WEIGHT is allocated to the **F1**-key.

- ⇒ Go to menu and select P2.6 DEVIATION
- ⇒ Use the arrow keys to select P2.6.6 SHORTCUTS
- ⇒ Press **F2**, P2.6.6.1 will be displayed along with the previous function for the **F1**-key.
- ⇒ Again press **F2** and the information line will start flashing.
- ⇒ Use the arrow keys to select DETERMINE REFERENCE WEIGHT and
- ⇒ Confirm by **PRINT**; this function has now been allocated to **F1**.

In weighing mode:

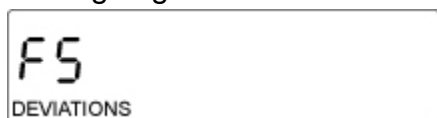

This completes setting the operating mode weighing by percentage.

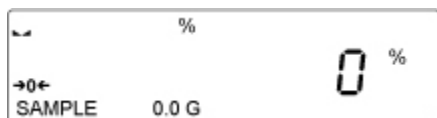

The percent symbol will be displayed at the upper margin of the display.

The setting SAMPLE 0.0 G will be displayed at the lower margin.

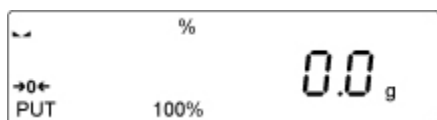
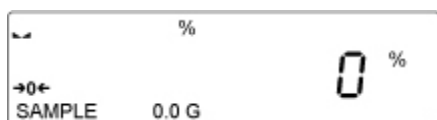

Put the reference weight equalling 100% on the weighing plate.

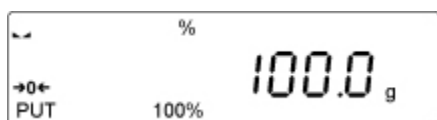

Example: 1 kg is supposed to be equivalent to 100%.

(example)

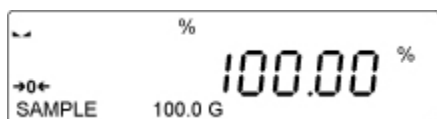

The reference weight of 1 kg has now been saved as 100% value.

Remove reference weight and place load. The weight will be displayed in percent according to reference weight.

- **Return to weighing mode**

Press **MODE** and F1 WEIGHING will be displayed. Confirm by pressing **PRINT** and the weighing scale will change to weighing mode.

- **Determining reference weight by weighing**

The ENTER REFERENCE WEIGHT function is allocated to the **F2**-key.

- ⇒ Go to menu and select P2.6 DEVIATION
- ⇒ Use the arrow keys to select P2.6.5 SHORTCUTS
- ⇒ Press **F2**, P2.6.5.1 will be displayed along with the previous function for the **F1**-key.
- ⇒ Press **F1** and entry for the **F2**-key will take place
- ⇒ Press **F2**.
- ⇒ Use the arrow keys to select ENTER REFERENCE WEIGHT and
- ⇒ confirm by **PRINT**; this function has now been allocated to **F2**.

In weighing mode:

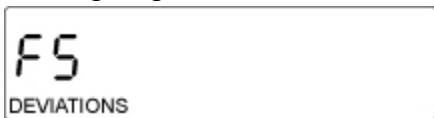

This completes setting the operating mode weighing by percentage.

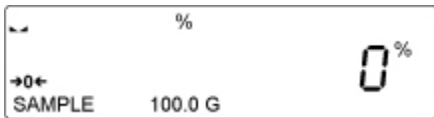

The previously entered reference weight will be displayed on the info line.

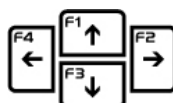
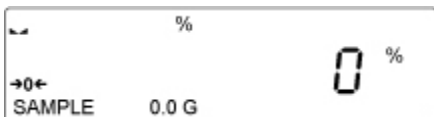

Use the arrow keys to enter the reference weight equalling 100% and confirm by pressing **PRINT**.

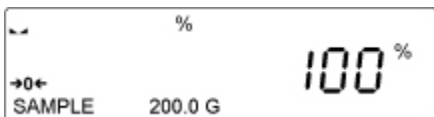

Example: 200 g

(example)

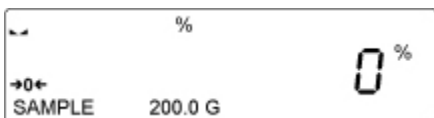

The reference weight of 200 g has now been saved as 100% value.

Remove reference weight and place load. The weight will be displayed in percent according to reference weight.

- **Return to weighing mode**

Press **MODE** and F1 WEIGHING will be displayed. Confirm by pressing **PRINT** and the weighing scale will change to weighing mode.

13.5 Animal weighing

The following options are available:

Medium time	This is the time required for taking the measurement; the mean value is taken
Threshold	This allows you to enter a threshold from which measurements are to be taken
Auto start	This allows you to decide when measurement is to be started: <ul style="list-style-type: none"> • Manually – after pressing a key or • Automatically – after selecting the START function

- **Manual confirmation**

In weighing mode:

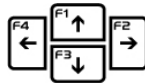

Use the arrow keys to select AUTOSTART NO.

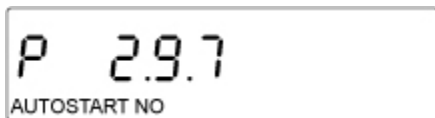

To return to weighing mode, press **UNIT**:



Use the arrow keys to select F8 mean value function.





The animal symbol will appear on the display.

Place weighing goods and press

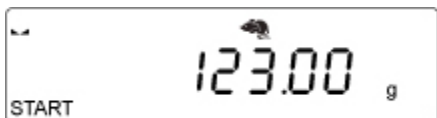

Measuring is started by pressing **F2**.



The mean value will be determined.

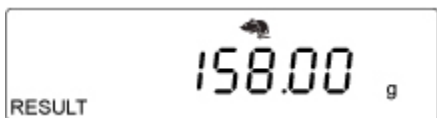

Afterwards the weighing result will be displayed.

(example)

To end weighing, press **UNIT**.

- **Return to weighing mode**

Press **MODE** and F1 WEIGHING will be displayed. Confirm by pressing **PRINT** and the weighing scale will change to weighing mode.

- **Carrying out automatic measuring**

In weighing mode:

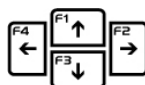
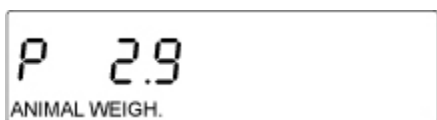

Use the arrow keys to select **AUTOSTART YES**.



To return to weighing mode, press **UNIT**:





Use the arrow keys to select F8 mean value function.



The animal symbol will appear on the display.

Place goods to be weighed on balance.



The weighing scale will start determining the mean value automatically.



(example)

Afterwards the weighing result will be displayed.

To end weighing, press **UNIT**.

- **Return to weighing mode**

Press **MODE** and F1 WEIGHING will be displayed. Confirm by pressing **PRINT** and the weighing scale will change to weighing mode.

13.6 Statistics

The statistics function allows you to collect data from a series of weighing processes that afterwards are statistically evaluated.

Statistics data available for calculation:

N	Number of samples
SUM	Total weight of samples
AVG	Mean value derived from batch
MIN	Min value in batch
MAX	Max value in batch
SDV	Standard Deviation
DIV	Difference between max and min in batch
SDV	Standard deviation for batch
RDV	Variance factor

• **F9 Selecting statistics:**



The statistics symbol appears on the display.

1. Put-on sample



Confirm with **PRINT**. The value will be saved to the alibi memory and printed out if a printer is connected.

(example)



The information line shows "1" for the first weighing process.

Remove the sample from the weighing plate and apply the same sequence of operations for additional samples.

(example)



After all values have been saved, the results are ready for evaluation under statistics.

Press the **F**-key.

(example)

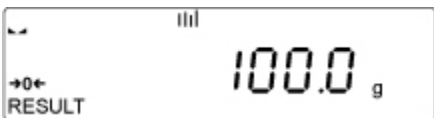

The arrow keys allow you to display all data:



Examples:

N	9	
SUM	455.600	G
AVG	50.6222	G
MIN	49.939	G
MAX	51.380	G
DIF	1.441	G
SDV	0.39605	G
RDV	0.78	%
PRINTING		



If the setting PRINT was selected, the statistical data can be printed out by pressing **PRINT**.

Example of report:

12:27	29/11/13	
-----Statistics-----		
-		
N		3
Sum		11439.5 g
Avg		3813.17 g
Min		457.0 g
Max		10000.0 g
Dif		9543.0 g
Sdv		4380.009 g
Rdv		114.87 %

• **F9 Delete statistics:**

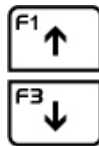
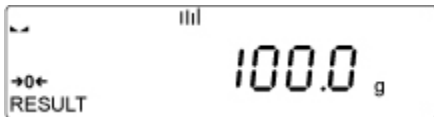

Use the arrow keys to select END.



Press **PRINT** and remove load.

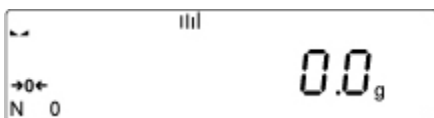

The start window for the statistics function will appear. Weighing data has been deleted.

• **Return to weighing mode**

Press **MODE** and F1 WEIGHING will be displayed. Confirm by pressing **PRINT** and the weighing scale will change to weighing mode.

13.7 Totalization

This function can be applied to add weighing different components of a compound. The adding-up function is available for up to 30 components.

- **Set F10 totalising:**

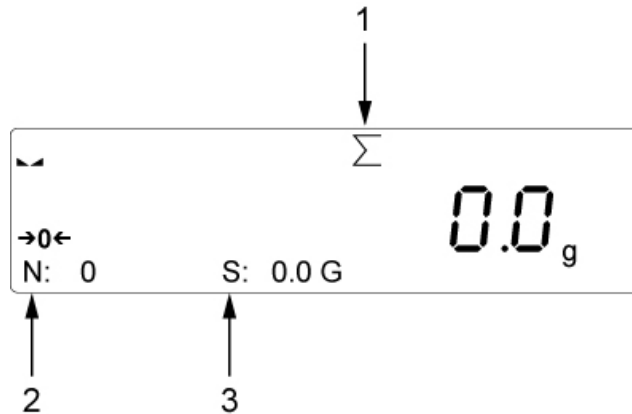
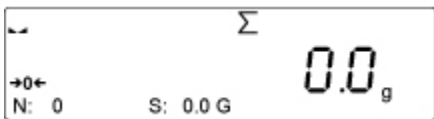

1	Symbol total
2	Quantity ingredients
3	Total weight of ingredients

- **Add up:**

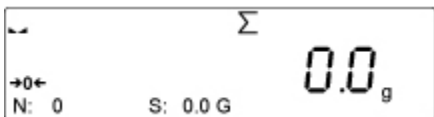

Place load A and wait until the stability display appears, the press **PRINT**.

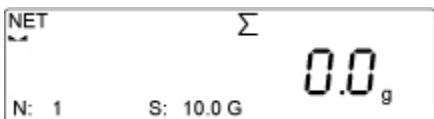

(example)

Weight is displayed as total, the weighing scale automatically tared (NET appears) followed by the zero display. "1" is displayed for number of ingredients.

Place load B and confirm by pressing **PRINT**.

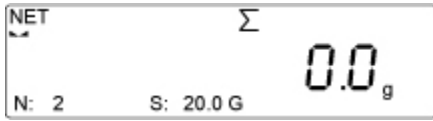

(example)

“2” is displayed for number of ingredients and the weight added to the summation memory.

With the further ingredients proceed as described above.

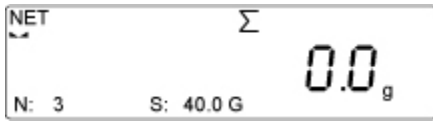

(example)

Once all ingredients have been added:

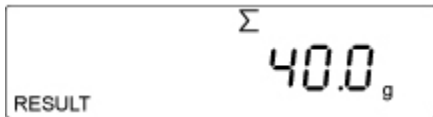
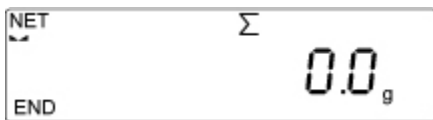
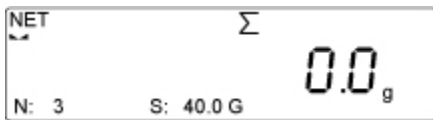

The total weight for the ingredients will be displayed and printed out if a printer is connected. The report contains the weight for all ingredients, the total and the tare weight.

Example of summation report:

-----Adding-up-----	
1.	1000.0 g
2.	2000.0 g

Sum	3000.0 g
Tare	0.0 g

- **Delete data**

To return to the start window of the adding-up function press **UNIT**. Data is reset to zero.

- **Return to weighing mode**

Press **MODE** and F1 WEIGHING will be displayed. Confirm by pressing **PRINT** and the weighing scale will change to weighing mode.

13.8 HOLD function

This function is used to determine the maximum value during a weighing process.

You may enter a threshold value from which measurement is to take place.

- **Set threshold value:**

We recommend entering the threshold value in grams.

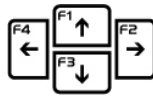

The display for entering the threshold value will appear with the left digit flashing. Use the arrow keys to enter the threshold value in grams and confirm by pressing **PRINT**.

As soon as this value is exceeded, the weighing scale will start measuring and the maximum value will be displayed.

- **Carry out measuring:**



The Hold function is now enabled. The net weight will be displayed on the info line.

The weighing scale is ready for measuring.

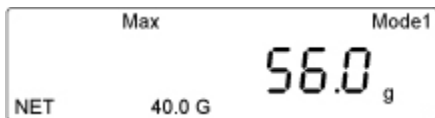

(example)

The maximum weight above the threshold value will be displayed on the main display. In addition the max symbol will appear.

To carry out additional measurements, remove the sample from the weighing plate and press **UNIT**.

- **Return to weighing mode**

Press **MODE** and F1 WEIGHING will be displayed. Confirm by pressing **PRINT** and the weighing scale will change to weighing mode.

14 Further useful functions “P6 OTHER“

Here, you can set the parameters that influence the operation of the balance, such as background lighting and key sounds.

14.1 Language

The following languages are available for the weighing menu:
GERMAN/SPANISH/FRENCH/POLISH/ENGLISH

Each language can be set as follows:



Previous language (example GERMAN) will be displayed.

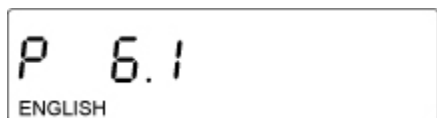

GERMAN will be flashing.
Use the arrow keys to select the language of your choice.



(example)



Example: Confirm SPANISH by pressing **PRINT**.



(example)

The desired language is now set.



To return to weighing mode, press **UNIT** repeatedly.

14.2 Authorisations

Three authorisation levels (See chap. 9.2) can be set for the access to the weighing scale menu:

ADMIN/USER/ADVANCED

Setting authorisations:



ACCESS LEV. ADMIN is displayed



ADMIN is flashing.

Use the arrow keys to select the desired authorisation.

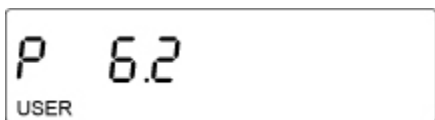

(example)



Example: Confirm USER by pressing **PRINT**.



(example)

The authorisation USER is now set.



To return to weighing mode, press **UNIT** repeatedly.

14.3 Acoustic signal for key operation

This setting allows you to enable or disable the audio signal by pressing any key.

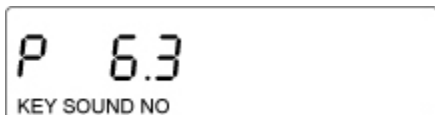

(example)



The previous setting for the audio signal will be displayed.

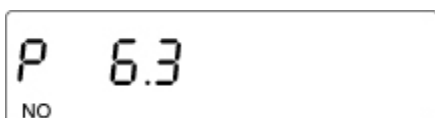

NO appears flashing.



Use the arrow keys to select the desired setting.

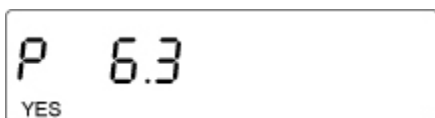

(example)



Example: Acknowledge YES with **PRINT**



(example)

The key-operated audio signal is now disabled.



To return to weighing mode, press **UNIT** repeatedly.

14.4 Backlight and brightness control for display

This menu item allows you to set the brightness of the display. In addition, backlight can be disabled completely.

- **100** Maximum brightness of display
- **10** Minimum brightness of display
- **NONE** Background illumination switched-off

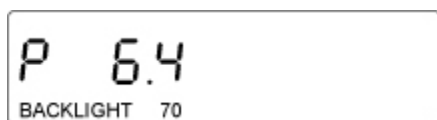

(example)



The previous setting for the backlight brightness will be displayed.

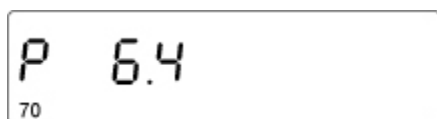

70 will be flashing.

Use the arrow keys to select the desired setting.



(example)



Example: Confirm 100 by pressing **PRINT**.

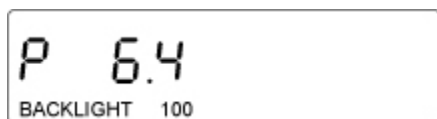

(example)

The brightness for the backlight is now set to 100, i.e. maximum brightness.



To return to weighing mode, press **UNIT** repeatedly.

14.5 Date



(example)



The previous date will be displayed.



The date format will be displayed. YYYY.MM.DD – Year-Month-Day and next to it the digits for the date settings. One of the digits will be flashing. Use the arrow keys to set the current date.



(example)



Confirm with **PRINT**



(example)

The current date is now set.



To return to weighing mode, press **UNIT** repeatedly.

14.6 Time

You can set the current time as follows:



(example)



The previous time will be displayed.

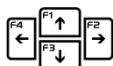

The time format will be displayed HH:MM – hours:minutes and next to it the digits for the time settings. One of the digits will be flashing. Use the arrow keys to enter the current time.

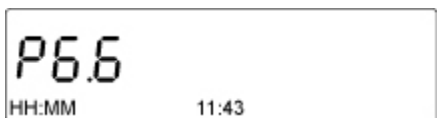

(example)



Confirm with **PRINT**



(example)

The current time is now set.



To return to weighing mode, press **UNIT** repeatedly.

14.7 Date format

This menu item allows you to set a date for the printout.

- **YYYY** Year
- **MM** Month
- **DD** Date

The following settings are possible:

YYYY.MM.DD / YYYY.DD.MM / DD.MM.YYYY / MM.DD.YY

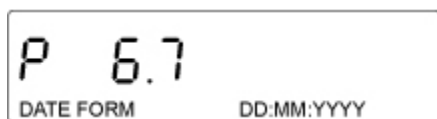

(example)



The previous date format will be displayed.



The date format DD.MM.YYYY – Day-Month-Year will be flashing. Use the arrow keys to select the desired format.



(example)



Confirm with **PRINT**

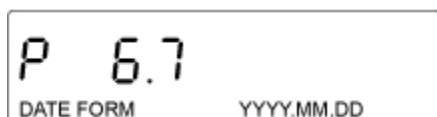

(example)

The format settings will be displayed.



To return to weighing mode, press **UNIT** repeatedly.

14.8 Time format

You can set a time format (12H/24H) for the printout.

If the **12 H** format is set, time will be shown with an **A** or **P** next to it.

- **A** Hours before noon
- **P** Hours after noon

The time on the printout will be printed with **AM** or **PM** next to it.



(example)



The previous time format will be displayed.



24 H will be flashing.
Use the arrow keys to select the desired format.



(example)



Confirm with **PRINT**



(example)

The format settings will be displayed.
From now on time will be displayed in this format.



To return to weighing mode, press **UNIT** repeatedly.

15 Weighing units

15.1 How to enable weighing units

Individual weight units can be enabled and disabled in the menu as follows:

Go to menu and select the following menu item:

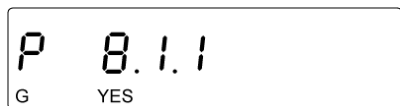
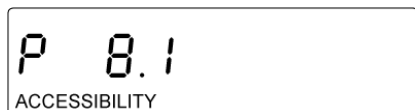

G YES will be displayed.

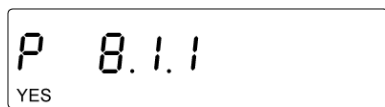

You can now enable (YES) or disable (NO) the weight unit gram.



Use the arrow keys to select the desired setting.

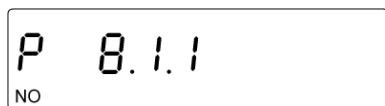

Confirm with **PRINT**

(example)

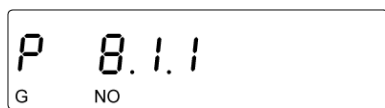

The weight unit gram has now been disabled and will no longer be displayed on pressing the **UNIT**-key.

To return to weighing mode, press **UNIT**.



For all other weight units follow the same sequence of operations.



Weighing scales with type approval options are restricted to **[g]** → **[kg]** → **[ct]**.

15.2 How to set a standard weight unit

The unit set in this function will remain after turning on or off and after disconnection from the mains.

Go to menu and select the following menu item:

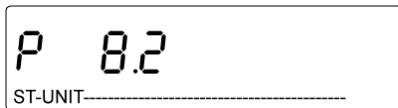
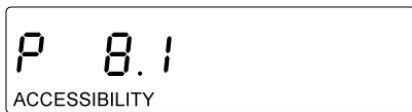

----- will be displayed flashing

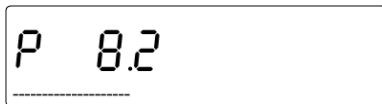

----- will be flashing.



Use the arrow keys to select the desired standard weight unit.

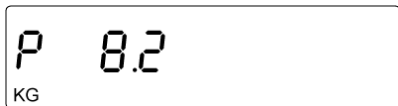

Confirm with **PRINT**

(example)

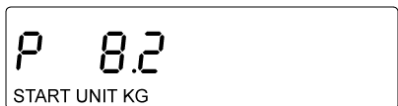

KG is now set as standard weight unit.

To return to weighing mode, press **UNIT**.



16 GLP/ISO report "P5.3 GLP PRINT"

Quality assurance systems require logs of weighing results as well as of correct adjustment of the balance stating date and time and balance identification. The easiest way is to have a printer connected.

The content for data output is configured specified in the "P5.3 GLP PRINT" menu. All parameters set to "YES" will be issued.

Examples:

Definition of a standard log:

P5.3 GLP PRINT

P5.3.1	DATE	YES	Issue date of measurement
P5.3.2	TIME	YES	Issue time of measurement
P5.3.3	USER	YES	Issue name of logged-in user
P5.3.4	PRODUCT	YES	Issue name of product
P5.3.5	VARIABLE 1	NO:	Issue value of variable 1
P5.3.6	VARIABLE 2	NO:	Issue value of variable 2
P5.3.7	TARE	YES	Tare value is issued
P5.3.8	GROSS	YES	Gross value is issued
P5.3.9	CURR.RES.	YES	Current weighing result (net weight) is issued
P5.3.10	JUST.PROT.	NO:	The last adjustment report is issued according to the settings for the printout of an adjustment report.
P5.3.11	SPECPRINT	NO:	One of the four special printouts is issued

Printout example:

Datum	21.11.2013
Time	9:54:39
User	Kern
Product	Flour
Tare	1000 g
Gross	2000 g
Current result	2000 g

P5.3.1 DATE – issue date

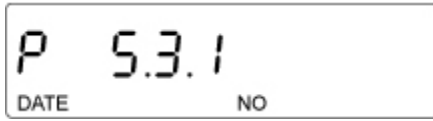

The previous setting will be displayed

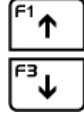

NO will be flashing
Use the arrow keys to select YES.

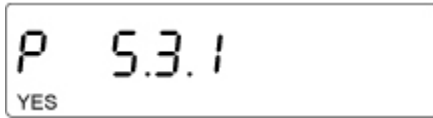

Confirm with **PRINT**



The date will be printed on the GLP report.
Press F1 to change to next setting.

P5.3.2 TIME – Issue time

Press , current setting will be flashing

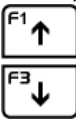
Press  to select among the following settings:

NO: = Do not display time
YES = Display time

Confirm settings by pressing the **PRINT** key. Weighing balance returns to menu.

Press  and the next menu item **P5.5.5 USER** will appear.

Follow the same sequence of operations for the remaining settings.

17 Data output RS 232 and USB

You can print weighing data automatically via the RS 232C interface or manually pressing the **PRINT** button via the interface according to the setting in the menu.

This data exchange is asynchronous using ASCII - Code.

The following conditions must be met to provide successful communication between the weighing balance and the printer.

- Use a suitable cable to connect the display unit to the interface of the printer. Faultless operation requires an adequate KERN interface cable.
- Communication parameters (baud rate, bits and parity) of display unit and printer must match.

17.1 Technical data

Baud rate	4800/9600/19200/38400/57600/115200 selectable
Parity	None, paired, unpaired
Transfer modes	<ul style="list-style-type: none">• Manually after pressing the PRINT key• Automatically according to stability display• Continuously, according to setting• On request by external device (remote control commands)

Menu item P3 COMMUNICATION allows you to adjust settings. The weighing scale is set up to communicate with the following external devices:

COM 1	RS 232 interface
COM 2	RS 232 interface
USB type A	Connection to computer keyboard, barcode scanner or USB stick
USB type B	Connection to printer or computer
WIFI	WIFI connection

USB connections cannot be configured.

17.2 Setting interface RS 232

Go to COM 1 or COM 2 and adjust settings as follows:

- **Setting of baud rate**



Go to menu and select menu item P3.1. To set the baud rate, press **F2**.



The previous baud rate will be displayed. Again press **F2**, setting will start flashing.

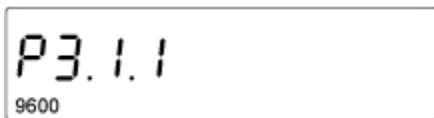

Use the arrow keys to select the desired baud rate and confirm by pressing **PRINT**.



(example)

The baud rate is now set. Press UNIT repeatedly until the weighing scale has returned to weighing mode.

- **Set parity**

Select menu item P3.1.2 and adjust settings for parity as described above.

17.3 Interface cable

- Cable weighing scale - computer (RS232):



17.4 Output log

17.4.1 Issue after pressing the PRINT button

i	The printout of unstable values is blocked in calibrated weighing scales.
----------	---

1	2	3	4 - 12	13	14 - 16	17	18
Stability symbol	Blank	Character	Weight	Blank	Unit	CR	LF

Stability symbol	[blank space]	If stable
	[?]	If stable
	[^]	If error (Command + exceeded)
	[v]	If error (Command – exceeded)
Character	[blank space]	For positive and negative values
Weight	9 digits	With right justifications
Unit	3 digits	With left justification

17.4.2 Remote control instructions

Feedback by weighing scale after sending remote control command:

XX_A	CR LF	Instruction accepted; will be executed
XX_I	CR LF	Instruction received; impossible to carry out
XX_^	CR LF	Command accepted but max range exceeded
XX_v	CR LF	Command accepted but min range exceeded
XX_E	CR LF	Error during execution, timeout for stable weighing value exceeded
XX		Name of command

1 – 3	4	5	6	7	8 – 16	17	18 - 20	21	22
Command	Blank	Stability symbol	Blank	Character	Weight	Blank	Unit	CR	LF

Instruction:	1-3	Character
Stabilisation symbol	[blank space]	If stable
	[?]	If stable
	[^]	If error (Command + exceeded)
	[v]	If error (Command – exceeded)
Character	[blank space]	For positive and negative values
Weight	9 digits	With right justifications
Unit	3 digits	With left justification

- **List of remote control commands**

Command	Description
Z	Balance zeroing
T	Tare weighing scale
OT	Enter tare value
UT	Set tare
S	Send stable result in standard unit
SI	Send result immediately in standard unit
SU	Send stable result in current unit
SUI	Send result immediately in current unit
C1	Enable continuous data output in standard unit
C0	Disable continuous data output in standard unit
CU1	Enable continuous data output in current unit
CU0	Disable continuous data output in current unit
PC	Send all implemented commands

i	Each command must end in CR LF suffix.
----------	--

18 Connecting external devices

To adjust settings for external devices go to menu item P4 DEVICES:

- **Adjusting connection to computer**

Go to menu item P4 DEVICES and set menu item P4.1 COMPUTER.

Select port where computer is to be connected.

Confirm port by pressing **PRINT** and press **UNIT** to return to weighing mode.

Optional connections:

COM 1 or COM 2:	RS232 interfaces
USB type B	USB connection
WIFI connection	

- **Adjust connection to computer**

Select menu item P4 DEVICES and set menu item P4.2 PRINTER.

Select port where computer is to be connected.

Confirm port by pressing **PRINT** and press **UNIT** to return to weighing mode.

Optional connections:

COM 1 or COM 2:	RS232 interfaces
-----------------	------------------

18.1 Printer settings

- **Printout examples**

Stable weighing value

5000.1 g

Unstable weighing value

? 5000.1 g

Negative weighed value

5000.1 g

Positive weighing value

5000.1 g

Overload

^

Percent determination

24.9 %

Parts counting

10 pcs

18.1.1 Setting an adjustment report

The following settings can be enabled (printout takes place) or disabled (printout blocked) by selecting YES or NO.

Sample adjustment record:

Select P 5.1 and adjust the desired settings.

Sample adjustment record:

P5.1.1	DRAFT		Enter a project name, maximum 16 characters
P5.1.2	KIND JUST	YES	Print kind of adjustment
P5.1.3	USER	YES	Print name of user
P5.1.4	DRAFT	YES	Print project name (See. P5.1.1)
P5.1.5	DATE	YES	Print date of adjustment
P5.1.6	TIME	YES	Print time of adjustment
P5.1.7	ID WEIGHING SCALE	YES	Print serial number of weighing scale
P5.1.8	DIFF.JUST.	YES	Print difference between currently adjustment weight and previous adjustment weight.
P5.1.9	LINES	YES	Print line between date and signature
P5.1.10	SIGNATURE	YES	Print box for signature of implementing person

Printout example adjustment report:

-----Just.Prot.-----	
Kind Just	External
User	Kern
Draft	
Datum	21.11.2013
Time	9:54:39
ID Balance	132051
Diff.Just.	-0.2 g
<hr/>	
Signature	
.....	

18.1.2 Set header

Select P 5.2 and adjust the desired settings.

Print header example:

P5.2.1	LINES	YES	Print line
P5.2.2	OPER. MODULE	YES	Print name of operating mode
P5.2.3	DATUM	YES	Print date on header
P5.2.4	TIME	YES	Print time on header
P5.2.5	WEIGHING SCALE TYPE	YES	Print weighing scale type
P5.2.6	ID WEIGHING SCALE	YES	Print serial number
P5.2.7	USER	YES	Print name of logged-in user
P5.2.8	PRODUCT	YES	Print name of product currently selected
P5.2.9	VARIABLE 1	YES	Print name of variable 1
P5.2.10	VARIABLE 2	YES	Print name of variable 2
P5.2.11	EMPTY LINE	YES	Print empty dividing line
P5.2.12	JUST.PROT.	YES	Print report for last adjustment
P5.2.13	SPECIAL PRINTOUT <ul style="list-style-type: none"> • NONE • SPEC 1 • SPEC 2 • SPEC 3 • SPEC 4 		Placing one of the four special printouts on the header

Printout example header:

Operating mode	Weighing
User	Kern
Datum	21.11.2013
Time	9:54:39
ID Balance	132051

18.1.3 Print measured result

You can adjust the settings that are to appear on the printout of the measured result.

Select P 5.3 GLP PRINTOUT and adjust the desired settings.

Example:

P5.3.1	DATE	YES	Print date of measurement
P5.3.2	TIME	YES	Print time of measurement
P5.3.3	USER	YES	Print name of logged-in user
P5.3.4	PRODUCT	YES	Print name of weighed product
P5.3.5	VARIABLE 1	YES	Print value of variable 1
P5.3.6	VARIABLE 2	YES	Print value of variable 2
P5.3.7	TARE	YES	Print tare value
P5.3.8	GROSS	YES	Print gross value
P5.3.9	CURR.RES.	YES	Print net weight in current unit
P5.3.10	JUST.PROT.	YES	Print report for last adjustment
P5.3.11	EMPTY LINE	YES	Print empty dividing line
P5.3.12	SPECIAL PRINTOUT <ul style="list-style-type: none"> • NONE • SPEC 1 • SPEC 2 • SPEC 3 • SPEC 4 		Placing one of the four special printouts on the header

Printout example:

Datum	21.11.2013
Time	9:54:39
User	Kern
Product	Flour
Tare	1000 g
Gross	2000 g
Current result	2000 g

18.1.4 Adjust footer

You can adjust the settings to be printed on the footer.

Select P 5.3 and adjust the desired settings.



19 Data bases

The weighing scale software contains three editable data bases (USER, PRODUCTS and TARING) and two data bases (WEIGHING and ALIBI) in which all measurements are stored.

- **Capacity of data bases:**

USER	10 different users
PRODUCTS	1000 different products
TARING	10 different packaging weights
WEIGHINGS	1000 measurements
ALIBI	100 000 measurements

- **Navigation in data bases USER, PRODUCTS and TARING:**

	Delete selected entry in data base
	Add new entry to data base

19.1 Data base USER

The following data can be entered for each user:

- NAME (30 characters), CODE (6 characters)
- PASSWORD (8 characters, numerals only)
- AUTHORISATIONS (USER, ADVANCED, ADMIN)
- LANGUAGE (all languages available in the weighing scale)

Authorisation levels:

The software contains three authorisation levels (See chap. 10.2)

- **Add user name**



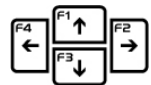
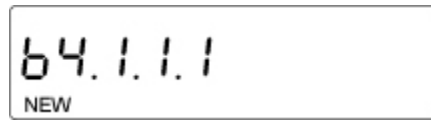
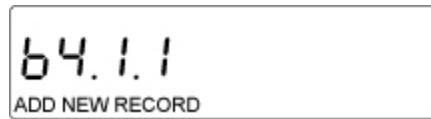
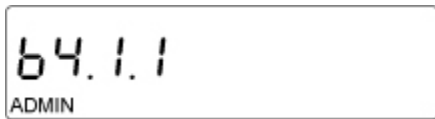

N will be flashing
Use the arrow keys to enter user name



(example)

You have successfully entered a user name.

After entering the user name, enter the following additional data with respect to the user:

- Add user code (max 8 characters, numerals only)

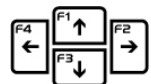
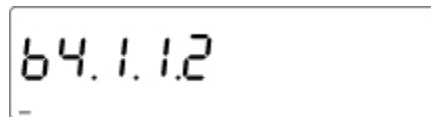
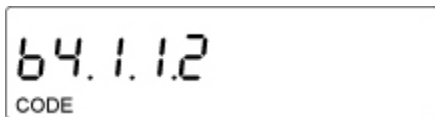

A short line will appear
Use the arrow keys to enter the 6-digit numeric code and confirm by pressing PRINT.



For details on authorisation levels please see chap. 10.2

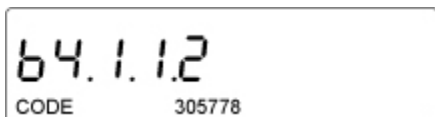

(example)

The code for this user is now saved in the data base.

Details to authorisation levels

- Add user password (max 8 characters)

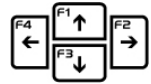
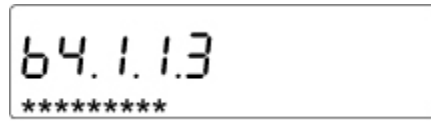

A short flashing line will appear
Use the arrow keys to enter the password and confirm by pressing **PRINT**.

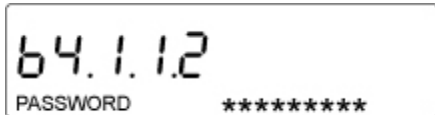

The password for this user is now stored in the data base.

- Setting authorisations for the user

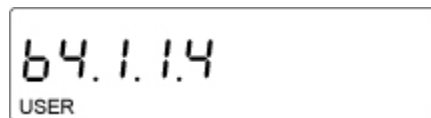

User name will be flashing.
Use the arrow keys to select the desired authorisation and confirm by pressing **PRINT**.



For further details on authorisations see chap. 10.2

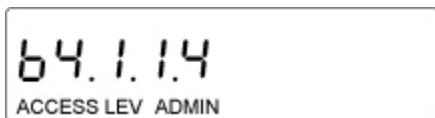

Authorisation as administrator has now been assigned to the user.

- **Select menu language for user**

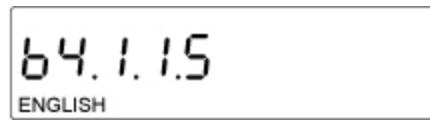

The language set previously will be flashing. Use the arrow keys to select the desired language and confirm by pressing **PRINT**.

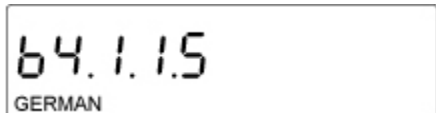

(example)

The language has now been assigned to the user.

After entering all data press **UNIT** to return to weighing mode.

For selecting users see chap. 10.1 Login/logout

- **Deleting a user**

Select b4.1 as described above

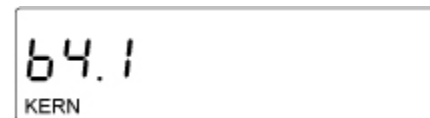

Use the arrow key to select the user to be deleted.



DELETE will appear.

Confirm with **PRINT**.

This indicates that the user has been deleted.

After entering all data press **UNIT** to return to weighing mode.

19.2 Data base products

The product data base can store up to 1000 products. You can create the following data for every product:

NAME (30 characters)	
CODE (6 characters)	
EAN (16 characters)	
WEIGHT	According to accuracy of the weighing scale's scale interval „d“
TARE	Weight of packaging for the product according to accuracy of the weighing scale's scale interval „d“
MIN	Lower threshold for operating mode CONTROL WEIGH, entry according to accuracy of the weighing scale's scale interval „d“
MAX	Upper threshold for operating mode CONTROL WEIGH, entry according to accuracy of the weighing scale's scale interval „d“
TOLERANCE	Threshold for tolerance on +/- for operating mode DISPENSE, entry as target weight %

- Add product and assign product name

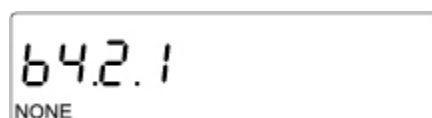

The previous setting will be displayed.

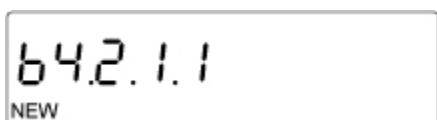
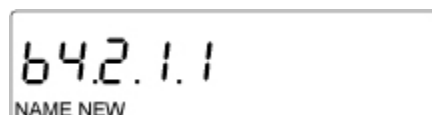

NEW will be displayed. „N“ will be flashing. Use the arrow keys to enter the name for the product and confirm by pressing **PRINT**.

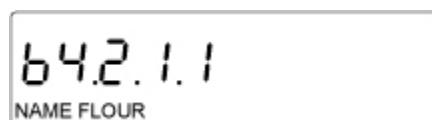
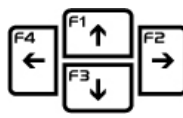

(example)
You have now saved the new product and name to the data base.

- **Entering code for product**

Select b4.2.1.2 CODE



An empty space will be flashing.
Use the arrow keys to enter the desired code for the product and confirm by pressing **PRINT**.

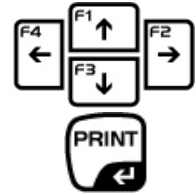

CODE 12345 (example) will be displayed and has been allocated to the product.

- **Entering EAN (barcode) for the product**

Select b4.2.1.3 EAN



An empty space will be flashing.
Use the arrow keys to enter the desired barcode for the product and confirm by pressing **PRINT**.

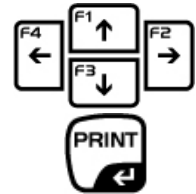

Barcode (example) will be displayed and has been allocated to the product.

- **Entering weight for product**

Select b4.2.1.4 Weight



Presented 000000
Use the arrow keys to enter the weight for the product and confirm by pressing **PRINT**.

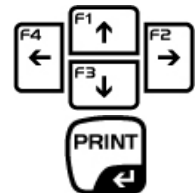

WEIGHT 1000.00 g (example) will be displayed and has been allocated to the product.

- **Entering tare weight of packaging for product**

Select b4.2.1.5 TARE



Presented 000000
Use the arrow keys to enter the weight of the packaging for the product and confirm by pressing **PRINT**.

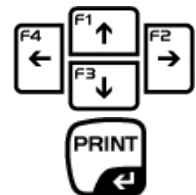

TARE 200.00 g (example) will be displayed and has been allocated to the product.

- **Entering lower limit during control weighing**

Select b4.2.1.6 MIN



Presented 000000

Use the arrow keys to enter the lower limit and confirm by pressing **PRINT**.

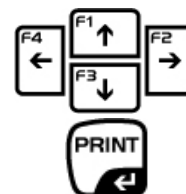

MIN 200.00 g (example) will be displayed and has been allocated to the product.

- **Entering upper limit during control weigh**

Select b4.2.1.7 MAX



Presented 000000

Use the arrow keys to enter the lower limit and confirm by pressing **PRINT**.

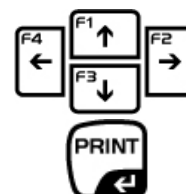

MAX 1500.00 g (example) will be displayed and has been allocated to the product.

- **Entering threshold value during dispense**

Select b4.2.1.8 MAX



Presented 000000

Use the arrow keys to enter the threshold value and confirm by pressing **PRINT**.

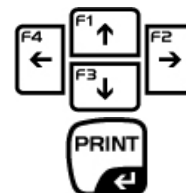

TOLERANCE 220.00 g (example) will be displayed and has been allocated to the product.

19.3 Data base Taring

This data base can store up to 10 different packaging weights. You can allocate the following data to each packaging.

NAME (30 characters)	
TARE	Weight of packaging for the product according to accuracy of the weighing scale's scale interval „d“

- Add name of packaging

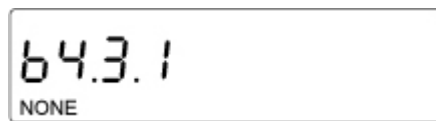

The previous setting will be displayed.

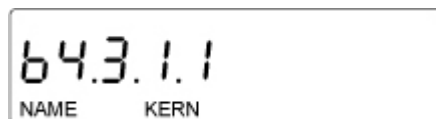
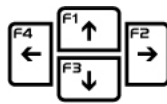
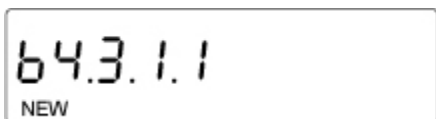
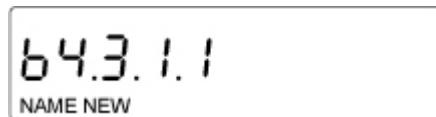

NEW will be displayed, N will be flashing.

Use the arrow keys to enter name of packaging and confirm by pressing PRINT.

(example)

The new product has been saved under its name to the data base. You may immediately afterwards enter the weight of the packaging.

- Entering weight of packaging

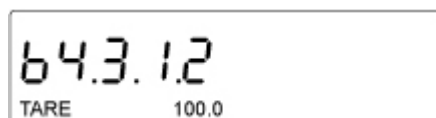
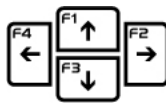
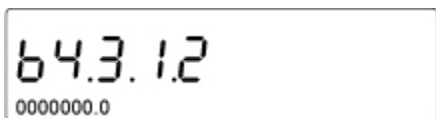
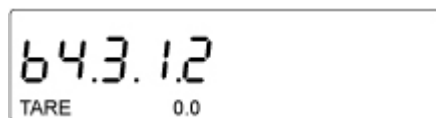

Use the arrow keys to enter the tare value and confirm by pressing PRINT.

(example)

The weight of the packaging has been saved.

19.4 Data base Weighing processes

This data base cannot be edited, i.e. the data of measurements is saved automatically. Data is only available for viewing, printing by a printer or transmission to an external USB-stick.

The weighing scale software can store up to 1000 measurements. On pressing **PRINT** they will be saved automatically to the data base WEIGH.

Date of measurement
Time of measurement
Measuring result (weight)
Value of tare used
Name of weighed product
Person who implemented measurement (logged-in user)
Operating mode used to carry out measurement
Value of variables 1 and 2

i	<ul style="list-style-type: none">• If measurement of 1001 was saved, measurement 1 will be overwritten automatically.• The measurements saved to data base Weighing cannot be deleted.
----------	---

- Saving measurements to data base WEIGH

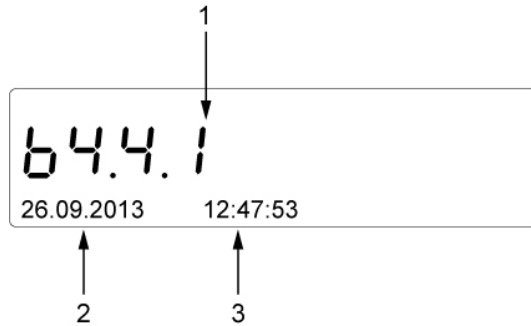
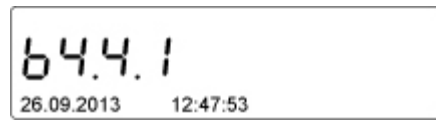

1	Number of measurement: Format: b4.4n N=number of measurement
2	Date of measurement
3	Time of measurement

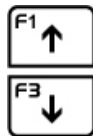

Use the arrow keys to change to the next saved measurement.



To invoke additional data for the measurement, press F.



(Date of measurement)

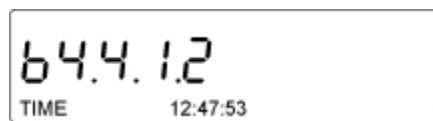

(Time of measurement)



(Weight of measurement)

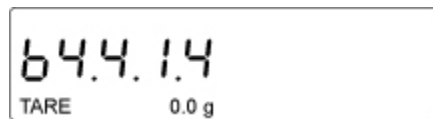
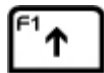

(Tare value of packaging)

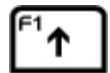

644.15
PRODUCT APPLES

(Name of product measured)

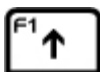

644.16
USER MAIER

(Name of logged-in user who carried out the measurement)



644.17
WORK MODE WEIGHING

(Selected operating mode used to carry out measurement)

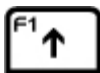

644.18
VARIABLE 1

644.19
VARIABLE 2

(Set variable)



644.1.10
PRINT

(Print measurement)



If a printer is connected, the saved data will be printed by pressing **PRINT**.



- The data printed depend on the settings in the GLP report (See chap. 15). The settings there set to YES will be printed.

Printout example:

Date	21.06.2013
Time	12:48:55
User	Kern
Product	Flour
	400.0 g
-----Just.Prot.-----	
Kind Just	External
User	Kern
Date	21.11.2013
Time	9:54:39
ID Balance	132051
Diff.Just.	-0.2 g

Signature	
.....	

19.5 Alibi memory

The weighing scale software can save up to 100 000 measurements. Measurements are saved automatically each time the **PRINT**-key is pressed. In addition to measurements other data is also saved:

- Date of measurement
- Time of measurement
- Measuring result (weight)
- Tare value
- Logged-in user
- Name of weighed product

i	<ul style="list-style-type: none"> • Measurement one will be deleted as soon as measurement 100 001 is saved. • Measurements saved to the alibi memory cannot be deleted.
----------	---

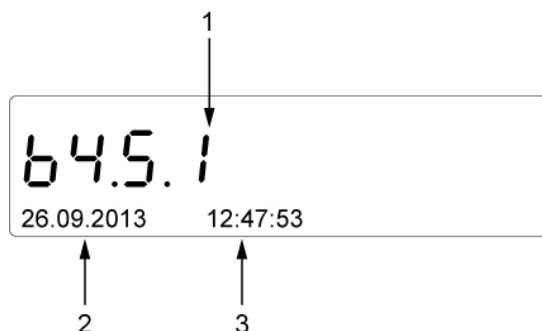
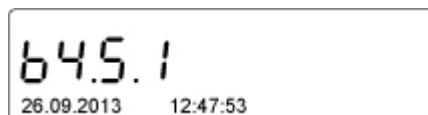

1	Number of measurement: Format: b4.5n N=number of measurement
2	Date of measurement
3	Time of measurement

Each can be invoked as described above (chap. 18.4).

If menu item b4.5.1.7 is selected and a printer connected, data can be printed by pressing **PRINT**. (Dependent on settings selected in GLP report chap. 15).

19.6 Exporting and importing data bases

The software of the weighing scale facilitates:

- Copying of data stored in the data bases PRODUCTS and TARE between two weighing scales of the same series.



- This process has to be performed via USB connection.
- For this purpose connect USB stick to USB port type A.

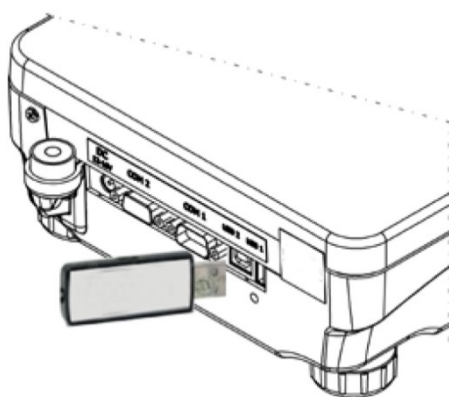

The weighing scale detects the USB stick automatically.



The display shows the message for import and export of data.



DataEXPORT



DataIMPRORT

- **Export data**

Selecting EXPORT



The following functions are available for selection:

IE 1.1	Export ALL DATA BASES
IE 1.2	Export USER data base
IE 1.3	Export PRODUCTS data base
IE 1.4	Export TARE data base
IE 1.5	Export WEIGHING data base
IE 1.6	Export the data saved in the ALIBI memory
IE 1.7	Export user PARAMETERS

If ALL DATA BASES is selected, the files will be saved under the respective names on the USB stick. The files have special extensions and are encrypted. They are not visible in the standard software.

i	<ul style="list-style-type: none"> • Data from the data bases ALIBI and WEIGHING cannot be imported.
----------	---

Data from the data bases PRODUCTS, USER and TARE can be read out.

- **Importing data**

The IMPORT function is used to transmit data between weighing scales.

To import data, insert the USB stick in the USB port type A.

Select IMPORT



IE 2.1	Export ALL DATA BASES
IE 2.2	Export USER data base
IE 2.3	Export PRODUCTS data base
IE 2.4	Export TARE data base
IE 2.5	Export user PARAMETER

	<ul style="list-style-type: none">• Data from the data bases ALIBI and WEIGHING cannot be imported.
--	---

20 Servicing, maintenance, disposal



Before any maintenance, cleaning and repair work disconnect the appliance from the operating voltage.

20.1 Clean

Please do not use aggressive cleaning agents (solvents or similar agents), but a cloth dampened with mild soap suds. Ensure that no liquid penetrates into the device. Polish with a dry soft cloth.

Loose residue sample/powder can be removed carefully with a brush or manual vacuum cleaner.

Spilled weighing goods must be removed immediately.

20.2 Servicing, maintenance

- ⇒ The appliance may only be opened by trained service technicians who are authorized by KERN.
- ⇒ Ensure that the balance is regularly calibrated, see chap. Monitoring of test resources.

20.3 Disposal

- ⇒ Disposal of packaging and appliance must be carried out by operator according to valid national or regional law of the location where the appliance is used.

22 Instant help

Possible causes of errors:

In case of an error in the program process, briefly turn off the balance and disconnect from power supply. The weighing process must then be restarted from the beginning.

Fault

The displayed weight does not glow.

The displayed weight is permanently changing

The weighing result is obviously incorrect

Automatic adjustment carried out frequently.

No data transfer between printer and balance.

The menu setting cannot be changed.

Possible cause

- The balance is not switched on.
- The mains supply connection has been interrupted (mains cable not plugged in/faulty).
- Power supply interrupted.
- Draught/air movement
- Table/floor vibrations
- Weighing pan has contact with other objects.
- Electromagnetic fields / static charging (choose different location/switch off interfering device if possible)
- The display of the balance is not at zero
- Adjustment is no longer correct.
- The balance is on an uneven surface.
- Great fluctuations in temperature.
- Electromagnetic fields / static charging (choose different location/switch off interfering device if possible)
- Severe temperature variations in the room or the instrument
- Communication settings are wrong.
- Menu item is locked for models with type approval certificate.

22.1 Error messages

Er1 Hi	Initial weight error
Er2 nuLL	Value below allowed range
Er3 FuL1	Value above allowed range
Er4 FuL2	Weighing range exceeded
Er5 rout	Value outside allowed range e.g. tare value ≤ 0 , Reference weight = 0
Er7 tout	Disconnecting time too short
Er8 outr	Input outside range e.g. for tolerance control: Input upper limit < lower limit
Er9 Lock	Function blocked
Er10 cal	Adjustment error e.g. incorrect adjustment weight}

23 Declaration of conformity



KERN & Sohn GmbH

D-72322 Balingen-Frommern

Postbox 4052

E-Mail: info@kern-sohn.de

Phone: 0049-[0]7433- 9933-0

Fax: 0049-[0]7433-9933-149

Internet: www.kern-sohn.de

Declaration of conformity

EG-Konformitätserklärung
EC- Déclaration de conformité
EC-Dichiarazione di conformità
EC- Declaração de conformidade
EC-Deklaracja zgodności

EC-Declaration of -Conformity
EC-Declaración de Conformidad
EC-Conformiteitverklaring
EC- Prohlášení o shode
ЕС-Заявление о соответствии

D	Konformitäts- erklärung	Wir erklären hiermit, dass das Produkt, auf das sich diese Erklärung bezieht, mit den nachstehenden Normen übereinstimmt.
GB	Declaration of conformity	We hereby declare that the product to which this declaration refers conforms with the following standards.
CZ	Prohlášení o shode	Tímto prohlašujeme, že výrobek, kterého se toto prohlášení týká, je v souladu s níže uvedenými normami.
E	Declaración de conformidad	Manifestamos en la presente que el producto al que se refiere esta declaración está de acuerdo con las normas siguientes
F	Déclaration de conformité	Nous déclarons avec cela responsabilité que le produit, auquel se rapporte la présente déclaration, est conforme aux normes citées ci-après.
I	Dichiarazione di conformità	Dichiariamo con ciò che il prodotto al quale la presente dichiarazione si riferisce è conforme alle norme di seguito citate.
NL	Conformiteit- verklaring	Wij verklaren hiermede dat het product, waarop deze verklaring betrekking heeft, met de hierna vermelde normen overeenstemt.
P	Declaração de conformidade	Declaramos por meio da presente que o produto no qual se refere esta declaração, corresponde às normas seguintes.
PL	Deklaracja zgodności	Niniejszym oświadczamy, że produkt, którego niniejsze oświadczenie dotyczy, jest zgodny z poniższymi normami.
RUS	Заявление о соответствии	Мы заявляем, что продукт, к которому относится данная декларация, соответствует перечисленным ниже нормам.

Electronic Balance: KERN AEJ_C / AES_C / PLJ-C

EU Directive	Standards
2004/108/EC	EN 61326-1: 2006
2006/95/EC	EN 61010-1: 2010

Datum 10.12.2013
Date

Ort der Ausstellung 72336 Balingen
Place of issue

Signatur
Signature

Albert Sauter
KERN & Sohn GmbH
Geschäftsführer
Managing director

KERN & Sohn GmbH, Ziegelei 1, D-72336 Balingen, Tel. +49-[0]7433/9933-0
Fax +49-[0]7433/9933-149, E-Mail: info@kern-sohn.com, Internet: www.kern-sohn.com