



KERN & Sohn GmbH

Ziegelei 1

D-72336 Balingen

E-Mail: info@kern-sohn.com

Tel: +49-[0]7433- 9933-0

Fax: +49-[0]7433-9933-149

Internet: www.kern-sohn.com

Operating instruction Analytical balance

KERN ABT

Version 1.1

12/2009

GB



ABT-BA-e-0911



KERN ABT

Version 1.1 12/2009

Operating instruction Analytical balance

Table of Contents

1	Technical data	5
2	Declaration of conformity	8
3	Keyboard and display overview	9
3.1	Keyboard overview.....	9
3.2	Overview of display.....	11
4	Basic Information (General)	12
4.1	Proper use.....	12
4.2	Improper Use	12
4.3	Warranty	12
4.4	Monitoring of Test Resources.....	13
5	Basic Safety Precautions	13
5.1	Pay attention to the instructions in the Operation Manual.....	13
5.2	Personnel training	13
6	Transport and storage	13
6.1	Testing upon acceptance	13
6.2	Packaging.....	13
7	Unpacking, Setup and Commissioning	14
7.1	Installation Site, Location of Use	14
7.2	Unpacking	14
7.2.1	Scope of delivery	15
7.2.2	Installation	16
7.3	Mains connection	17
7.4	Connection of peripheral devices	17
7.5	Initial Commissioning	18
7.5.1	Turning On the Power	18
8	Adjustment	19
8.1	Automatic adjustment via PSC	19
8.1.1	PCS function ON/OFF	20
8.2	Automatic adjustment via Clock-CAL	21
8.2.1	Setting the time for Clock-CAL	22
8.3	Adjustment via preset process	23
8.3.1	Selecting default adjustment method	23
8.3.2	Default setting: Adjustment with internal weight.....	24
8.3.3	Default setting: Adjustment test with internal weight.....	24
8.3.4	Default setting: Adjustment test with external weight.....	25
8.4	Carrying out alternative adjustment methods	26
8.4.1	Adjustment with internal weight.....	26
8.4.2	Adjustment test with internal weight.....	27
8.4.3	Adjustment test with external weight.....	28

9	Verification	29
10	ISO/GLP log.....	30
10.1	Setting the log printout of your adjustment data	30
10.2	Balance ID Number Setting	31
10.3	Setting the date printout	32
10.3.1	Printout Date and Time, without weight value	32
11	Basic Operation	33
11.1	Weighing	33
11.2	Taring.....	33
11.3	Changing the display	34
11.4	Changing readability	35
11.5	Underfloor weighing.....	36
12	The menu	37
12.1	Changing settings	37
12.2	How to change settings	37
12.3	Call up menu	38
12.4	Selecting the menu.....	39
12.5	Menu overview	40
12.6	Menu Lock.....	43
12.7	Resetting the menu	43
12.8	Settings control display	44
13	Description of individual functions	45
13.1	Stability filter	45
13.1.1	Standard mode.....	45
13.1.2	Anti-convection mode.....	46
13.1.3	High-stability Mode.....	46
13.1.4	Apportioning mode	47
13.2	Standstill display	48
13.3	Auto Zero.....	49
13.4	Setting date	50
13.5	Setting time	51
13.6	Capacity display	52
14	Application Functions	53
14.1	Parts counting	53
14.2	Percent determination.....	54
14.3	Density determination.....	55
14.3.1	Density determination of solids	55
14.3.2	Determining density of liquids	56
14.4	Auto Print	58
14.5	Add up mode.....	59
14.6	Recipe mode	61

15	Data output	63
15.1	RS 232C interface	63
15.2	Data Formats	63
15.3	Remote control instructions	64
15.4	Standard Settings	65
15.5	User Settings	66
15.5.1	Communication speed settings.....	67
15.5.2	Delimiter settings.....	67
15.5.3	Parity settings.....	67
15.5.4	Stop bit settings.....	68
15.5.5	Input-output data format settings	68
15.5.6	Handshake settings	68
16	Service, maintenance, disposal	69
16.1	Cleaning	69
16.2	Service, maintenance	69
16.3	Disposal	69
17	Instant help	70

1 Technical data

KERN	ABT 100-5M	ABT 120-4M
Readability (d)	0.01 mg	0.1 mg
Weighing range (max)	101 g	120 g
Minimum load (Min)	1 mg	10 mg
Verification value (e)	1 mg	1 mg
Verification class	I	I
Reproducibility	0.05 mg	0.1 mg
Linearity	± 0.15 mg	± 0.2 mg
Stabilization time	10 sec	3 sec
Adjustment weight	internal	
Weighing units (calibrated appliances)	g, ct	
Smallest part weight for piece counting	1 mg	1 mg
Reference quantities at piece counting	10, 20, 50,100	
Weighing plate, stainless steel	ø 80mm	
Dimensions of the hous- ing (B x D x H)	217 x 356 x 338	
Dimensions Glass wind screen [mm]	Weighing room 168 x172 x223	
Net weight (kg)	7	
Permitted environmental condition	+10° C to +30° C	
Humidity of air	max. 80 % relative (not condensing)	
Voltage	230 V/50Hz	

KERN	ABT 220-4M	ABT 320-4M
Readability (d)	0.1 mg	0.1 mg
Weighing range (max)	220 g	320 g
Minimum load (Min)	10 mg	10 mg
Verification value (e)	1 mg	1 mg
Verification class	I	I
Reproducibility	0.1 mg	0.1 mg
Linearity	± 0.2 mg	± 0.2 mg
Stabilization time	3 sec	
Adjustment weight	internal	
Weighing units (calibrated appliances)	g, ct	
Smallest part weight for piece counting	1 mg	0,1 mg
Reference quantities at piece counting	10, 20, 50,100	
Weighing plate, stainless steel	ø 80mm	
Dimensions of the hous- ing (B x D x H)	217 x 356 x 338	
Dimensions Glass wind screen [mm]	Weighing room 168 x172 x223	
Net weight (kg)	7	
Permitted environmental condition	+10° C to +30° C	
Humidity of air	max. 80 % relative (not condensing)	
Voltage	230 V/50Hz	

KERN	ABT 120-5DM	ABT 220-5DM
Readability (d)	0.01/0.1 mg	0.01/0.1 mg
Weighing range (max)	42 g/120 g	82 g/220 g
Minimum load (Min)	1 mg	1 mg
Verification value (e)	1 mg	1 mg
Verification class	I	I
Reproducibility	±0.02/ 0.1 mg	±0.05/ 0.1 mg
Linearity	± 0.05/0.2 mg	± 0.1/0.2 mg
Stabilization time	3sec./10 sec.	
Adjustment weight	internal	
Weighing units (calibrated appliances)	g, ct	
Smallest part weight for piece counting	1 mg	
Reference quantities at piece counting	10, 20, 50,100	
Weighing plate, stainless steel	ø 80mm	
Dimensions of the hous- ing (B x D x H)	217 x 356 x 338	
Dimensions Glass wind screen [mm]	Weighing room 168 x172 x223	
Net weight (kg)	7	
Permitted environmental condition	+10° C to +30° C	
Humidity of air	max. 80 % relative (not condensing)	
Voltage	230 V/50Hz	

2 Declaration of conformity



KERN & Sohn GmbH

D-72322 Balingen-Frommern

Postfach 4052

E-Mail: info@kern-sohn.de

Tel: 0049-[0]7433- 9933-0

Fax: 0049-[0]7433-9933-149

Internet: www.kern-sohn.de

Declaration of conformity

Declaration of conformity for apparatus with CE mark

Konformitätserklärung für Geräte mit CE-Zeichen

Déclaration de conformité pour appareils portant la marque CE

Declaración de conformidad para aparatos con marca CE

Dichiarazione di conformità per apparecchi contrassegnati con la marcatura CE

- English** We hereby declare that the product to which this declaration refers conforms with the following standards.
- Deutsch** Wir erklären hiermit, dass das Produkt, auf das sich diese Erklärung bezieht, mit den nachstehenden Normen übereinstimmt.
- Français** Nous déclarons avec cela responsabilité que le produit, auquel se rapporte la présente déclaration, est conforme aux normes citées ci-après.
- Español** Manifestamos en la presente que el producto al que se refiere esta declaración está de acuerdo con las normas siguientes
- Italiano** Dichiariamo con ciò che il prodotto al quale la presente dichiarazione si riferisce è conforme alle norme di seguito citate.

Electronic Balance: KERN ABT

Mark applied	EU Directive	Standards
	2004/108/EC EMC	EN45501 EN55022
	2006/95/EC Low Voltage	EN60950

Date: 30.11.2009

Signature: 

Gottl. KERN & Sohn GmbH
Management





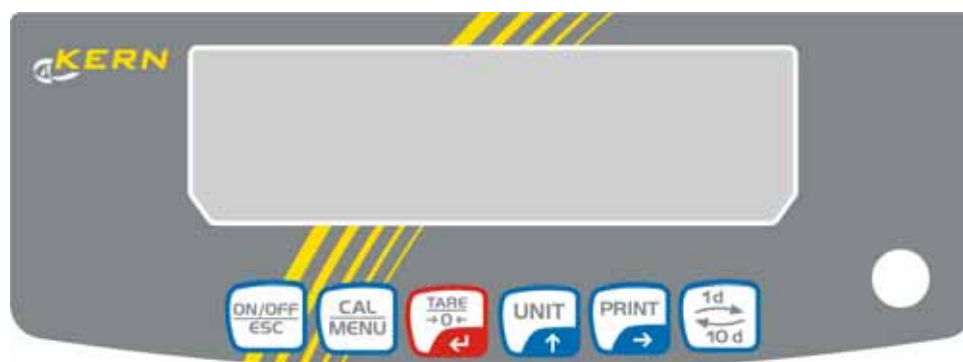

Gottl. KERN & Sohn GmbH, Ziegelei 1, D-72336 Balingen, Tel. +49-[0]7433/9933-0, Fax +49-[0]7433/9933-149

3 Keyboard and display overview







3.1 Keyboard overview



In weighing mode:

Key	Designation	Pressed once and released	Keep pressed for about 3 seconds
	[ON/OFF]	Switches between the operation and standby modes.	Switches the key notification buzzer on/off.
	[CAL]	Invokes adjustment or menu selection.	Invokes adjustment or menu selection.
	[TARE]	Tare or set weight display to zero	
	[UNIT]	Changing the display	
	[PRINT]	Issue of weighing value to external appliances (printer, PC)	Issue of date and time to external appliances.
	[1d/10d]	ABT 120-4M ABT 220-4M ABT 320-4M	For verified applications cutting off the last digit is only possible for models with a readout of 0,01 mg. For all other models the button 1/10d is inoperable.
		ABT 100-5M ABT 120-5DM ABT 220-5DM	

In menu:

Key	Designation	Pressed once and released	Keep pressed for about 3 seconds
	[ON/OFF]	Back to menu	Return to weighing mode
	[CAL]	Menu selection	
	[TARE]	Parameter selection Storing settings	
	[UNIT]	Entering numeric values Increases the numeric value of flashing digit by 1.	
	[PRINT]	Entering numeric values. Shifts flashing digit.	
	[1d/10d]	No effect.	

3.2 Overview of display

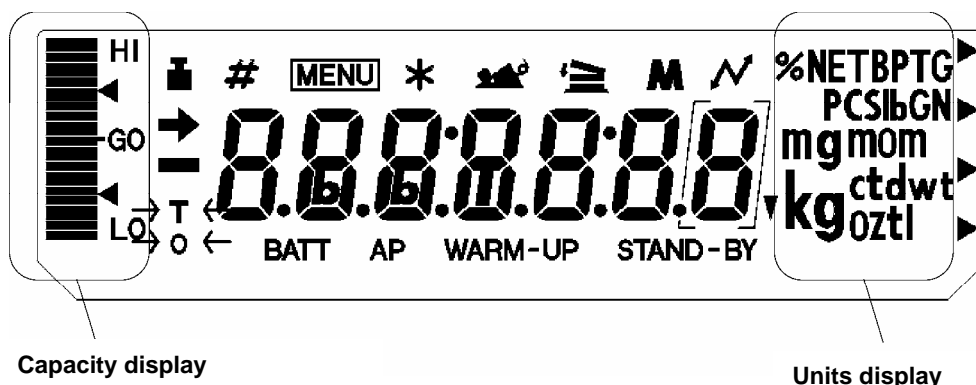

Display	Designation	Description
→	Standstill display	Indicates that the weighed value is stable. Highlights current setting during menu item selection
	Weight symbol	Appears during adjustment. Flashes prior to start of automatic adjustment. Appears during parameter selection for adjustment. Blinks to advise necessity of adjustment.
#	Number symbol	Indicates numeric value entry.
MENU	Menu symbol	Appears during menu selection. Always shown when the menu is locked.
*	Asterisk	Indicates that the displayed numeric value is not a mass value.
	Add-on symbol	Indicates set-up of Add-on mode.
	Communication symbol	Is lit up during communication with external appliances via RS-232C cable. Shown when communication functions are ON.
BATT	Battery symbol	Indicates a low battery voltage when using the balance with the optional battery pack.
AP	Auto Print symbol	Indicates set-up of the Auto Print function.
STAND-BY	Standby mark	Appears during standby status of balance.
▼	Inverse triangle symbol	Illuminates as part of the solid specific gravity measurement display.

4 Basic Information (General)

4.1 Proper use

The balance you purchased is intended to determine the weighing value of material to be weighed. It is intended to be used as a “non-automatic“ balance, i.e. the material to be weighed is manually and carefully placed in the centre of the weighing plate. As soon as a stable weighing value is reached the weighing value can be read.

4.2 Improper Use

Do not use balance for dynamic add-on weighing procedures, if small amounts of goods to be weighed are removed or added. The “stability compensation“ installed in the balance may result in displaying an incorrect measuring value! (Example: Slowly draining fluids from a container on the balance.)

Do not leave permanent load on the weighing plate. This may damage the measuring system.

Impacts and overloading exceeding the stated maximum load (max) of the balance, minus a possibly existing tare load, must be strictly avoided. Balance may be damaged by this.

Never operate balance in explosive environment. The serial version is not explosion protected.

The structure of the balance may not be modified. This may lead to incorrect weighing results, safety-related faults and destruction of the balance.

The balance may only be used according to the described conditions. Other areas of use must be released by KERN in writing.

4.3 Warranty

Warranty claims shall be voided in case

- Our conditions in the operation manual are ignored
- The appliance is used outside the described uses
- The appliance is modified or opened
- Mechanical damage or damage by media, liquids, natural wear and tear
- The appliance is improperly set up or incorrectly electrically connected
- The measuring system is overloaded

4.4 Monitoring of Test Resources

In the framework of quality assurance the measuring-related properties of the balance and, if applicable, the testing weight, must be checked regularly. The responsible user must define a suitable interval as well as type and scope of this test. Information is available on KERN's home page (www.kern-sohn.com) with regard to the monitoring of balance test substances and the test weights required for this. In KERN's accredited DKD calibration laboratory test weights and balances may be calibrated (return to the national standard) fast and at moderate cost.

5 Basic Safety Precautions

5.1 Pay attention to the instructions in the Operation Manual

Carefully read this operation manual before setup and commissioning, even if you are already familiar with KERN balances.

5.2 Personnel training

The appliance may only be operated and maintained by trained personnel.

6 Transport and storage

6.1 Testing upon acceptance

When receiving the appliance, please check packaging immediately, and the appliance itself when unpacking for possible visible damage.

6.2 Packaging

Keep all parts of the original packaging in case you need to return the appliance.

Only use original packaging for returning.

Before sending, disconnect all connected cables and loose/movable parts.

Attach possibly existing transport safeguards. Secure all parts, e.g. weighing plate, power unit etc., to prevent slipping and damage.

7 Unpacking, Setup and Commissioning

7.1 Installation Site, Location of Use

The balances are designed in a way that reliable weighing results are achieved in common conditions of use.

You will work accurately and fast, if you select the right location for your balance.

Therefore, observe the following for the installation site:

- Place the balance on a firm, level surface;
- Avoid extreme heat as well as temperature fluctuation caused by installing next to a radiator or in the direct sunlight;
- Protect the balance against direct draughts due to open windows and doors;
- Avoid jarring during weighing;
- Protect the balance against high humidity, vapours and dust;
- Do not expose the device to extreme dampness for longer periods of time. Non-permitted condensation (condensation of air humidity on the appliance) may occur if a cold appliance is taken to a considerably warmer environment. In this case, acclimatize the disconnected appliance for ca. 2 hours at room temperature.
- Avoid static charge of goods to be weighed or weighing container.





If electro-magnetic fields or static charge occur, or if the power supply is unstable major deviations on the display (incorrect weighing results) are possible. In that case, the location must be changed.

7.2 Unpacking

Carefully remove the balance from the packaging, remove plastic cover and setup balance at the intended workstation.

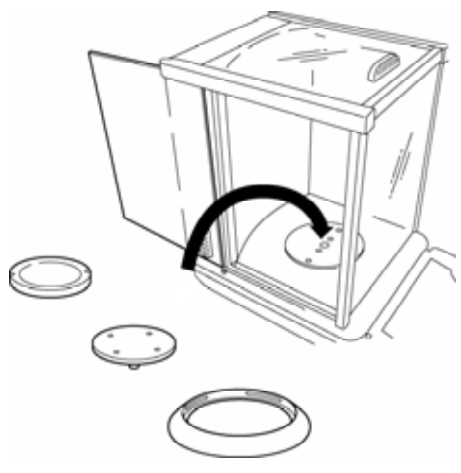
7.2.1 Scope of delivery

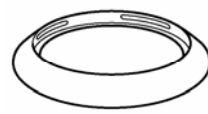
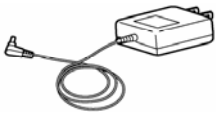
Serial accessories:

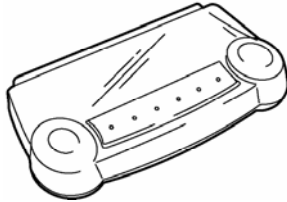
Balance	
Weighing plate	
Carrier of weighing plate	
Screening ring	
Mains adapter	
Adapter cable holder	
Protective cover	
Operating Manual	

7.2.2 Installation

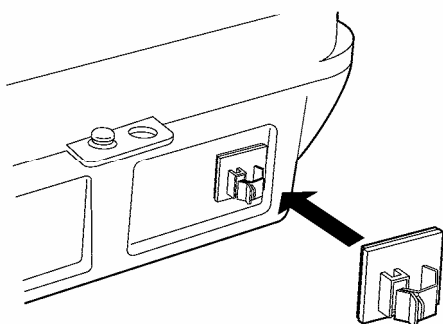

- Attach the adapter cable holder. Peel the protective sheet of adhesive of the adapter cable holder, and stick it on the back of the balance as shown in the figure.

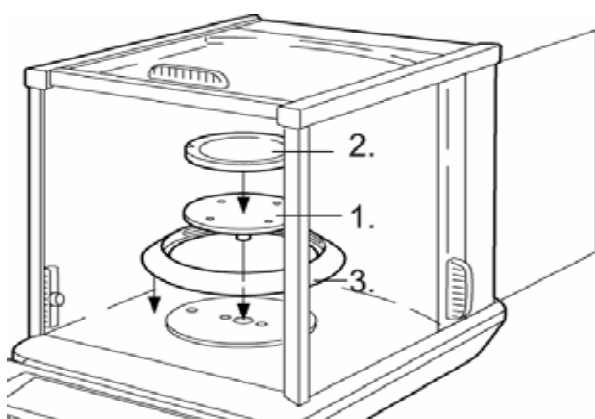

- Carrier of weighing plate, attach weighing plate and circular screen in order.



- Level balance with foot screws until the air bubble of the water balance is in the prescribed circle.
- When the key panel and the display must be protected from dirt and wear, place the cover over the key panel.

7.3 Mains connection

Power is supplied via the external mains power supply. The stated voltage value must be the same as the local voltage. Only use original KERN mains power supplies. Using other makes requires consent by KERN.

7.4 Connection of peripheral devices

Before connecting or disconnecting of additional devices (printer, PC) to the data interface, always disconnect the balance from the power supply.

With your balance, only use accessories and peripheral devices by KERN, as they are ideally tuned to your balance.

Terminal for external devices:

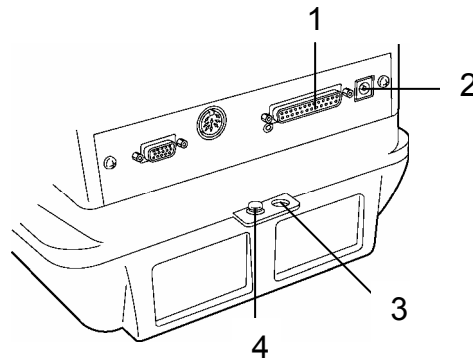

- 1 RS -232 interface
- 2 Mains connector
- 3 Anti-theft safety device (for chains or other fastenings)
- 4 Connection earthing terminal

7.5 Initial Commissioning

A warming up time of 4 hours after switching on stabilizes the measuring values. The accuracy of the balance depends on the local acceleration of gravity. Strictly observe hints in chapter Adjustment.

7.5.1 Turning On the Power

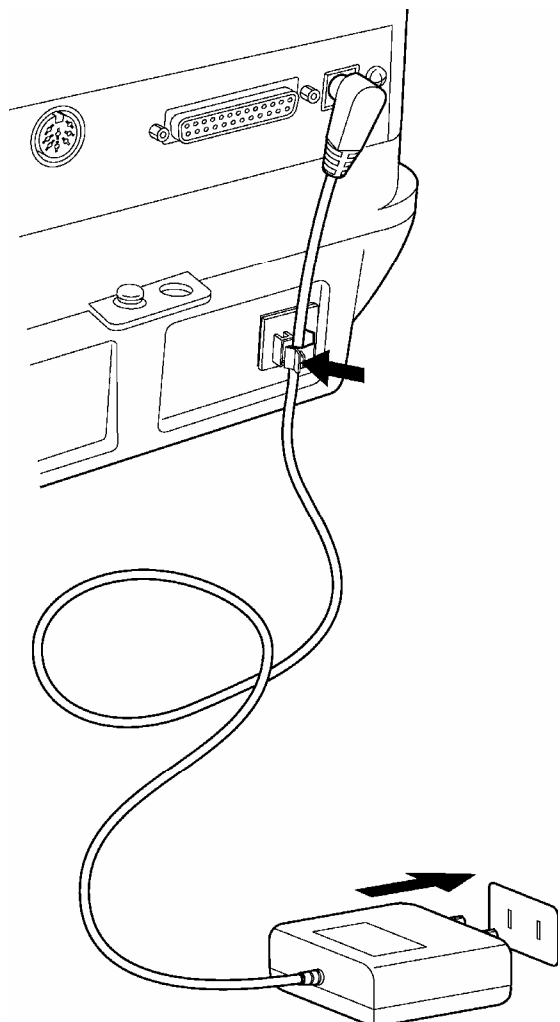

1. Supply power to balance via mains adapter. After the balance performs a self check, calibration will be automatically executed. During this process, the display will change as follows. "CHE 5", "CHE 4" "CHE 0", "CHE 2", "CHE 1", "CAL 2 – CAL 0", "CAL-End", "oFF". This adjustment can be interrupted immediately after switching-on the power supply by actuating the **[ON/OFF]**-key. However, at least one adjustment must be carried out before the balance can be used.
2. Actuate the **[ON/OFF]** key. After all displays appear, the gram (g) symbol appears.
3. Pressing the **[ON/OFF]** key again turns on the standby symbol and puts the balance in standby (warm up) status. Current time (see ch. 13.5) will be displayed.

8 Adjustment

As the acceleration value due to gravity is not the same at every location on earth, each balance must be coordinated - in compliance with the underlying physical weighing principle - to the existing acceleration due to gravity at its place of location (only if the balance has not already been adjusted to the location in the factory). This adjustment process must be carried out for the first commissioning, after each change of location as well as in case of fluctuating environment temperature. To receive accurate measuring values it is also recommended to adjust the balance periodically in weighing operation.

Observe stable environmental conditions. Stabilisation requires a warm-up period of 1 or 4 hours (for models $d = 0.01$ mg). Ensure that there are no objects on the weighing plate.

8.1 Automatic adjustment via PSC

The default setting for balances of the series ABT ("PSC ON") prompts automatic adjustment via the PSC function.

The moment a change in temperature is detected this function uses the internal tare weight to carry out fully-automatic adjustment with the help of a temperature sensor. If PSC is left ON, when there is a temperature change that would influence sensitivity, span calibration executes automatically to maintain the sensitivity of the balance. Adjustment in weighing mode is carried out automatically under the following conditions:

- (1) If a change in environmental temperature (0.5 °C) occurs;
- (2) When about four hours has passed since the previous calibration.
- (3) When the balance is switched from standby status to weighing mode and condition (1) or (2) has been met.
- (4) When balance was disconnected from the mains.

If one of the above conditions was met in weighing mode, the weight symbol flashes for about two minutes in order to notify the pending adjustment; afterwards the display will show "PSC run". During operation, the display will automatically change and the motor sound of the weight loading system is heard. In order to ensure proper PSC operation, prevent vibrations and air flow. As soon as the display in grams reappears after completing adjustment via PSC, the balance returns to weighing mode. The sensitivity before and after adjustment is slightly different. Also, no measurements can be made during adjustment. To prevent a start-up of adjustment during a measuring process you have to actuate the **[ON/OFF]** key as soon as the weight symbol starts flashing. This will interrupt automatic adjustment.

8.1.1 PCS function ON/OFF

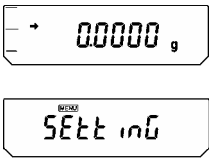
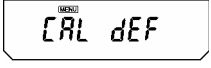
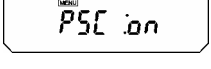
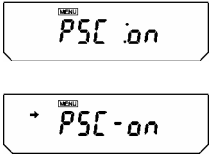
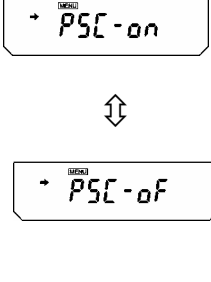
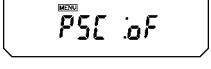
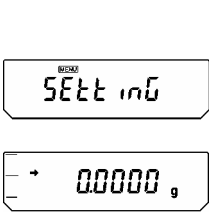
	<p>Press the [CAL] key repeatedly until "SettinG" appears.</p>
	<p>Press the [TARE] key. The display shows "CAL dEF".</p>
	<p>Actuate the [CAL] key repeatedly until the current "PSC:***" setting appears:</p>
	<p>To change the setting, actuate the [TARE] key as soon as "PSC:***" appears.</p>
	<p>You can use the [CAL] key to select between the following settings:</p> <p>"PSC-on" Function activated</p> <p>"PSC-of" Function deactivated</p> <p>The current setting is indicated by the standstill display (➔).</p>
	<p>Confirm your selection by pressing the [TARE] key</p>
	<p>To exit the function, press the [ON/OFF] key.</p> <p>Brief actuation of ON/OFF key: Back to previous menu.</p> <p>Long actuation of ON/OFF key: Back to weighing mode.</p>



PSC and Clock-CAL may be turned on and off separately. The setting control display (see ch. 12.6) shows the weight symbol (■), when PSC or Clock-CAL or both functions are activated.

8.2 Automatic adjustment via Clock-CAL (only models ABT 100-5M, ABT 120-5DM, ABT 220-5DM)

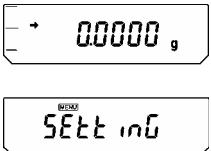

With the help of its internal adjusting weight and integrated clock the balance can be set to carry out automatic adjustment at set times (up to three times daily). Clock-CAL is a very convenient function, when calibration reports are desired to be made for regular calibrations, or when wishing span calibrations during break times to avoid interruption of measurement work.

The weight symbol blinks for about two minutes as notification of span calibration before it begins. Automatic adjustment can be stopped by actuating the **[ON/OFF]** key during this message.

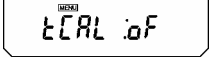
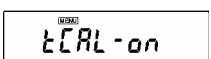
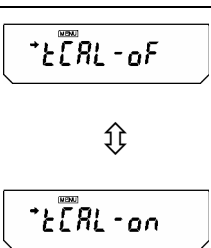
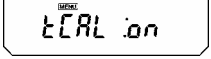
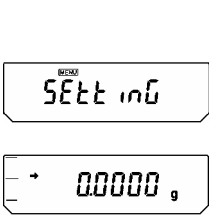
Clock-CAL function ON/OFF:

	<p>Press the [CAL] key repeatedly until "Setting" appears.</p>
	<p>Press the [TARE] key. The display shows "CAL dEF".</p>
	<p>Actuate the [CAL] key repeatedly until the current "tCal:**" setting appears:</p>
	<p>To change the setting, actuate the [TARE] key as soon as "tCal:**" appears.</p>
	<p>You can use the [CAL] key to select between the following settings:</p> <p>"tCAL-on" Function activated</p> <p>"tCAL-oF" Function deactivated</p> <p>The current setting is indicated by the standstill display (➔).</p>
	<p>Confirm your selection by pressing the [TARE] key</p>
	<p>To exit the function, press the [ON/OFF] key.</p> <p>Brief actuation of ON/OFF key: Back to previous menu.</p> <p>Long actuation of ON/OFF key: Back to weighing mode.</p>

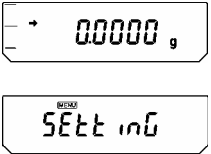
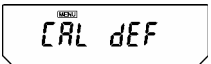
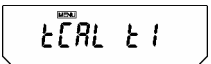
8.2.1 Setting the time for Clock-CAL

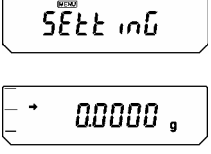

	<p>Press the [CAL] key repeatedly until "Setting" appears.</p>
	<p>Press the [TARE] key. The display shows "CAL dEF".</p>
 <p>(for setting 1)</p>	<p>Press the [CAL] key repeatedly until "tCAL t*" appears:</p>
	<p>Actuate the [TARE] key until "t*HH:MM" is displayed. The * - position symbolises a number between 1 and 3 (3 set times for automatic adjustment). The currently set time is displayed in "HH:MM" (HH for hours, MM for minutes) format with the first digit on the left flashing. The time appears as "__:__" when no time is set. The [MENU] symbol, and the # symbol appear to indicate it is in the numerical input status.</p>
	<p>Pressing the [PRINT] key moves the blinking digit to the next digit to the right. Press the [UNIT] key to change the value of the blinking digit. When the [UNIT] key is pressed, the numerical of the blinking digit increases by 1 at a time. The numerals progress in this order: 0→1→2→...→9→_→0... Set the hours within the range of 00 to 23 and the minutes within the range of 00 to 59. Complete your setting by pressing the [TARE] key. The display returns to "t CAL t*".</p>
	<p>In order to set another time, press the [CAL] key to move to the next "t CAL t*" setting and set the time in the same way.</p>
	<p>Actuate the [ON/OFF] key repeatedly. Return to menu/weighing mode.</p>
	<p>Clearing the Settings</p> <p>The clock settings "tCAL t1" to "tCAL t3" may each be reset by using procedure 3 to set the time setting to "__:__".</p>

PSC and Clock-CAL may be turned on and off separately. The setting control display (see ch. 12.6) shows the weight symbol (■), when PSC or Clock-CAL or both functions are activated.



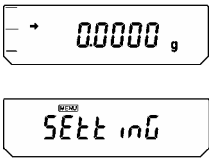
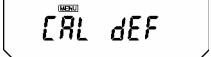
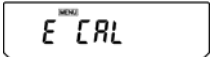

8.3 Adjustment via preset process

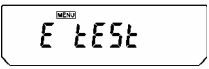
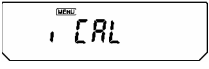
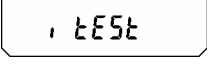
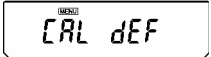
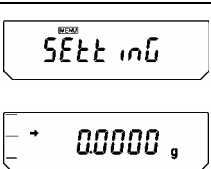
It is possible to start the preset adjustment method without having to access the menu. When in weighing mode, the preset adjustment method can be carried out by simply actuating the **[CAL]** key, followed by **[TARE]**.

8.3.1 Selecting default adjustment method



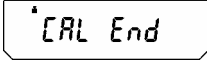

	<p>Press the [CAL] key repeatedly until "SettinG" appears.</p>	
	<p>Press the [TARE] key. The display shows "CAL dEF".</p>	
	<p>Press the [TARE] key. The display shows "E CAL"</p>	
	<p>Press the [CAL] key repeatedly until the desired setting appears. The standstill display (→) appears when current adjustment is displayed.</p> <p>Select amongst the following four types:</p>	
		<p>Not documented</p>
		<p>Adjustment test with external weight (see ch. 8.3.4)</p>
		<p>Adjustment test with internal weight (see ch. 8.3.2)</p>
	<p>Adjustment test with internal weight (see ch. 8.3.3)</p>	
	<p>Confirm your setting by pressing the [TARE] key. The display shows "CAL dEF".</p>	
	<p>To exit the function, press the [ON/OFF] key.</p> <p>Brief actuation of ON/OFF key: Back to previous menu.</p> <p>Long actuation of ON/OFF key: Back to weighing mode.</p> <p>The selected adjustment can be carried out by simply actuating the [CAL] key followed by [TARE].</p>	

8.3.2 Default setting: Adjustment with internal weight



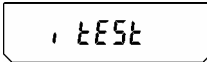
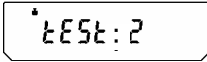

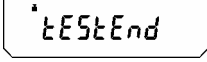

 	<p>Condition: Function „i tCAL“ activated (see ch. 8.3.1)</p> <p>Press the [CAL] key The display shows “i-CAL”</p>
 	<p>Press the [TARE] key. The display changes automatically in this order: “CAL 2”, “CAL 1”, “CAL 0”, and “CAL End”. After successful adjustment the balance automatically returns to weighing mode.</p> <p>In case of an adjustment error (e.g. objects on the weighing plate) the display will show an error message, repeat adjustment.</p>

8.3.3 Default setting: Adjustment test with internal weight

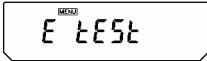
During adjustment tests the balance automatically compares the saved value of the adjustment weight with the actual value. This is only a check, i.e. no values are changed.

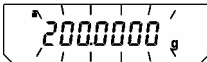
 	<p>Condition: Function „i tEST“ activated (see ch. 8.3.1)</p> <p>Press the [CAL] key The display shows “i-tEST”</p>
	<p>Press the [TARE] key. The display changes automatically in this order: “tEST 2”, “tEST 1”, “tEST 0”</p>
  	<p>After this, the difference to the previous adjustment will be displayed for several seconds.</p> <p>After "tEST End" was displayed, the balance will automatically return to weighing mode.</p>

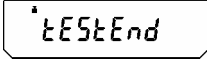



8.3.4 Default setting: Adjustment test with external weight

 	<p>Condition: Function „E tEst“ activated (see ch. 8.3.1)</p> <p>Press the [CAL] key The display shows “E-tEst”</p>
	<p>Press the [TARE] key. Testing will be started and zero display is flashing (Ensure that no items are present on the weighing plate).</p>
 <p>(Example)</p>	<p>Wait until the weighing value for adjustment is shown and flashes.</p>
	<p>Place the required adjusting weight on the weighing plate.</p> <p>Wait until the blinking zero display reappears. (this may take about 30 seconds.)</p> <p>Remove the weight from the weighing plate.</p>
  	<p>After this, the difference to the previous adjustment will be displayed for several seconds.</p> <p>After "tEst End" was displayed, the balance will automatically return to weighing mode.</p>

8.4 Carrying out alternative adjustment methods

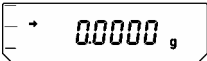
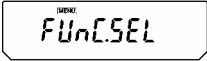
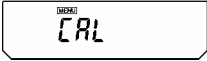

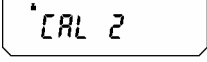
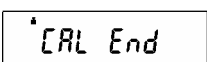
Here you start adjustment by selecting a setting in the menu.

8.4.1 Adjustment with internal weight





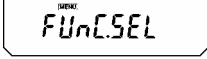
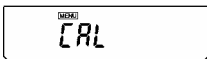

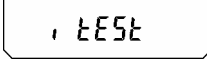
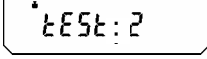
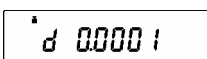
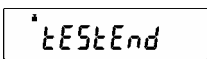
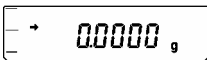

 	Repeatedly press the [CAL] key until "FUnC.SEL" appears.
	Press the [TARE] key. "CAL" is displayed.
	Press the [TARE] key. "E CAL" is displayed.
	Repeatedly press the [CAL] key until "i CAL" appears.
	Press the [TARE] key. The display changes automatically in this order: "CAL 2", "CAL 1", "CAL 0", and "CAL End".
 	After successful adjustment the balance automatically returns to weighing mode. In case of an adjustment error (e.g. objects on the weighing plate) the display will show an error message, repeat adjustment.

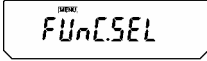
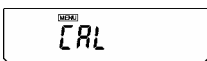
8.4.2 Adjustment test with internal weight

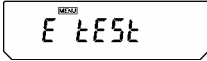
During adjustment tests the balance automatically compares the saved value of the adjustment weight with the actual value. This is only a check, i.e. no values are changed.

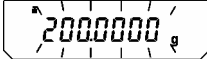
 	<p>Repeatedly press the [CAL] key until "FUnC.SEL" appears.</p>
	<p>Press the [TARE] key. "CAL" is displayed.</p>
	<p>Press the [TARE] key. "E CAL" is displayed.</p>
	<p>Repeatedly press the [CAL] key until "i tEst" appears.</p>
	<p>Press the [TARE] key. The display changes automatically in this order: "tEst 2", "tEst 1", "tEst 0"</p>
  	<p>After this, the difference to the previous adjustment will be displayed for several seconds.</p> <p>After "tEst End" was displayed, the balance will automatically return to weighing mode.</p>

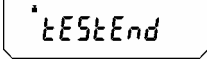
8.4.3 Adjustment test with external weight

 	<p>Repeatedly press the [CAL] key until "FUnC.SEL" appears.</p>
	<p>Press the [TARE] key. "CAL" is displayed.</p>
	<p>Press the [TARE] key. "E CAL" is displayed.</p>
	<p>Repeatedly press the [CAL] key until "i tEst" appears.</p>
	<p>Press the [TARE] key. Testing is started and zero display is flashing. (Ensure that there are no objects on the weighing plate).</p>
 (Example)	<p>Wait until the weighing value for adjustment is shown and flashes.</p>
	<p>Place the required adjusting weight on the weighing plate.</p> <p>Wait until the blinking zero display reappears. (this may take about 30 seconds.)</p> <p>Remove the weight from the weighing plate.</p>
  	<p>After this, the difference to the previous adjustment will be displayed for several seconds.</p> <p>After "tEst End" was displayed, the balance will automatically return to weighing mode.</p>

9 Verification

General introduction:

According to EU directive 90/384/EEC balances must be verified if they are used as follows (legally controlled area):

- a) For commercial transactions if the price of goods is determined by weighing.
- b) For the production of medicines in pharmacies as well as for analyses in the medical and pharmaceutical laboratory.
- c) For official purposes.
- d) For manufacturing final packages.

In cases of doubt, please contact your local trade in standard.

Verification instructions

An EU type approval exists for balances described in their technical data as verifiable. If a balance is used where obligation to verify exists as described above, it must be verified and re-verified in regular intervals.

Re-verification of a balance is carried out according to the respective national regulations. The validity for verification of balances in Germany is e.g. 2 years.

The legal regulation of the country where the balance is used must be observed!

After verification the balance is sealed at the indicated positions.

Verification of the balance is invalid without the "seal".

Position of the "official seals":

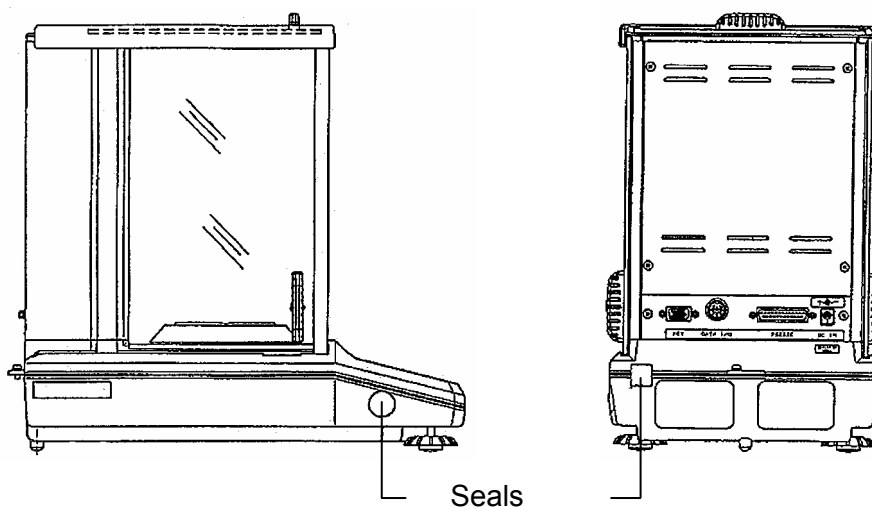

Balances with obligation to verify must be taken out of operation if:



- The **weighing result** of the balance is outside the **error limit**. Therefore, in regular intervals load balance with known test weight (ca. 1/3 of the max. load) and compare with displayed value.
- The **reverification** deadline has been exceeded.

10 ISO/GLP log

Quality assurance systems require printouts of weighing results as well as of correct adjustment of the balance stating date and time and balance identification. The easiest way is to have a printer connected.

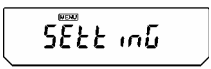
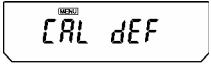
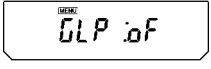
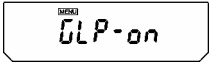
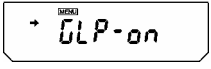
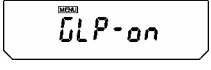
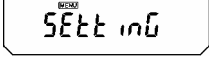

10.1 Setting the log printout of your adjustment data

This function enables automatic log issue after each adjustment. These logs may be issued by using an optional printer. Fully automatic and periodical adjustments are carried out and logs created in combination with the Clock-CAL function (see ch. 8.2). First make adjustments as specified in chap. 15.4 under „KERN-YKB-01N“. Then set the log printout as follows:

 	<p>Press the [CAL] key repeatedly until "Setting" appears.</p>
	<p>Press the [TARE] key. The display shows "CAL dEF".</p>
	<p>Repeatedly actuate the [CAL] key until "GLP:***" appears (The ** symbolise the current setting).</p>
	<p>To change settings, actuate the [TARE] key when "GLP:***" appears.</p>
	<p>You can use the [CAL] key to select between the following settings:</p> <p>"GLP-on" Function activated</p> <p>"GLP-oF" Function deactivated</p> <p>The current setting is indicated by the standstill display (➔).</p>
	<p>Confirm your selection by pressing the [TARE] key</p>
 	<p>Actuate the [ON/OFF] key repeatedly. Return to menu/weighing mode.</p>

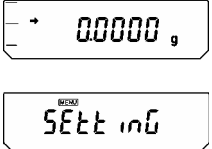
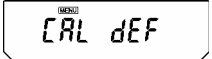

10.2 Balance ID Number Setting

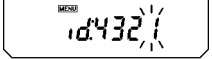
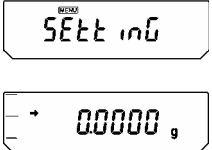
This setting is for the balance ID number that is output along with the adjustment report.

	<p>Press the [CAL] key repeatedly until "Setting" appears.</p>
	<p>Press the [TARE] key. The display shows "CAL dEF".</p>
	<p>Repeatedly actuate the [CAL] key until "id:****" appears (The ** symbolise the current setting).</p>
	<p>Press the [TARE] key. In the upper part of the display panel, the [MENU] symbol and the # symbol appear in order to indicate numerical input status. The leftmost digit of ***** blinks. The numeral of the blinking digit can be changed.</p>
	<p>When the [UNIT] key is pressed, the numerical of the blinking digit increases by 1 at a time. You can determine the value of the flashing digit, or shift the flashing digit by one position to the right, by pressing the [PRINT] key. Confirm your setting by pressing the [TARE] key.</p>
	<p>Actuate the [ON/OFF] key repeatedly. Return to menu/weighing mode.</p>

10.3 Setting the date printout

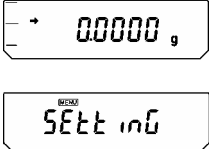
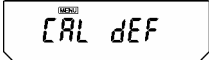
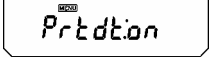
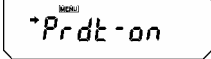
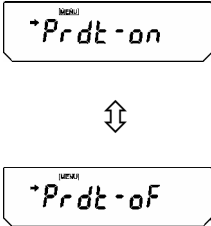
This setting determines whether or not the date and time on the balance's built-in clock is printed out along with the log.

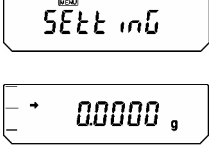
	<p>Press the [CAL] key repeatedly until "Setting" appears.</p>
	<p>Press the [TARE] key. The display shows "CAL DEF".</p>
	<p>Repeatedly actuate the [CAL] key until "Prtd:**" appears (The ** symbolise the current setting).</p>
	<p>To change settings, actuate the [TARE] key when "Prtd:**" appears.</p>
	<p>You can use the [CAL] key to select between the following settings:</p> <p>"Prtd-on" Date and time are printed.</p> <p>"Prtd-of" Date and time are not printed.</p> <p>The current setting is indicated by the standstill display (➔).</p>
	<p>Confirm your selection by pressing the [TARE] key</p>
	<p>Actuate the [ON/OFF] key repeatedly. Return to menu/weighing mode.</p>

10.3.1 Printout Date and Time, without weight value

To print out only date and time, without weight value, press **[PRINT]** button for approx. 3 sec.

11 Basic Operation

11.1 Weighing

Note: Stabilisation requires a warm-up period of 1 or 4 hours (for models d = 0.01 mg).

- ⇒ Turn on balance by pressing the **[ON/OFF]** key. The balance will carry out a self-test. Your balance is ready to weigh as soon as the "0.0000 g" display appears.

Note: The **[TARE]** key can be used to set the balance to zero at any time.

- ⇒ Place goods to be weighed on balance. Wait until the standstill display (→) appears, then read the weighing result.

11.2 Taring

The dead weight of any weighing container may be tared away by pressing a button, so that the following weighings show the net weight of the goods to be weighed.

- ⇒ Place empty tare container on the weighing plate. The total weight of the container is displayed.
- ⇒ To start the taring process press the **[TARE]** key. The weight of the container is now internally saved.
- ⇒ Place the goods to be weighed into the tare container.
- ⇒ Read the weight of the goods on the display.

Note:

The balance is able to only store one taring value at a time.

When the balance is unloaded the saved taring value is displayed with negative sign. Remove all items from the weighing plate in order to delete the stored tare value and subsequently press the **[TARE]** key.

The taring process can be repeated any number of times. The limit is reached when the whole weighing range is exhausted.



11.3 Changing the display

You can change the display to activated units, piece counting, percentage and density determination mode by pressing the **[UNIT]** key several times.

The default setting provides the following options:

[g] → **[%]** → **[Pcs]** → **[ct]** → **[g]** → ...

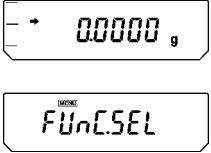
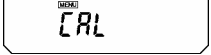
Different settings have to be activated in the menu:

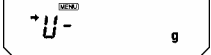
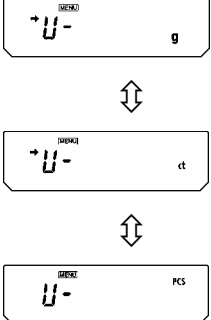
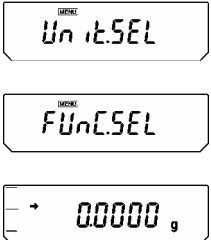
	<p>Repeatedly press the [CAL] key until "FUnC.SEL" appears.</p>
	<p>Press [TARE] key</p>
	<p>Repeatedly press the [CAL] key until "Unit.SEL" appears.</p>
	<p>Press [TARE] key</p>
	<p>To select settings, use the [CAL] key: Current settings are indicated by the standstill display (➔). Confirm your selection by pressing the [TARE] key. The [TARE] key is also used to deactivate a unit or function if the corresponding setting with standstill display is shown in the display.</p>
	<p>Repeatedly press the [ON/OFF] key. This takes you back to the menu/weighing mode.</p>

11.4 Changing readability

(only models ABT 100-5M, ABT 120-5DM, ABT 220-5DM)

Models ABT 120-5DM and ABT 220-5DM are set to “lower range” with a readability of 0.01 mg as soon as they are connected to power supply and turned on. To switch to the “upper range” with a minimum display of 0.1mg, press the **[1d/10d]** key.

If the lower max. weighing range (82g for ABT 220-5DM, 42 g for ABT 120-5DM) is exceeded during the weighing process, the balance changes automatically to the upper range.

If you tare the balance in the upper range, this setting will be maintained throughout. To return to lower range, you will have to actuate the **[TARE]** key after the stability symbol (→) has appeared.

Lower range:

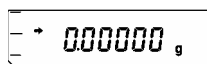

Upper range:

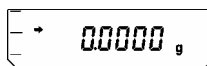

11.5 Underfloor weighing

Objects unsuitable for placing on the weighing pan due to size or shape may be weighed with the help of the flush-mounted platform.

Proceed as follows:

- Switch off balance.
- Open the closing lid (1) on the bottom of your balance.
- Place your balance over an opening.
- Suspend the goods to be weighed from the hook and carry out the weighing.

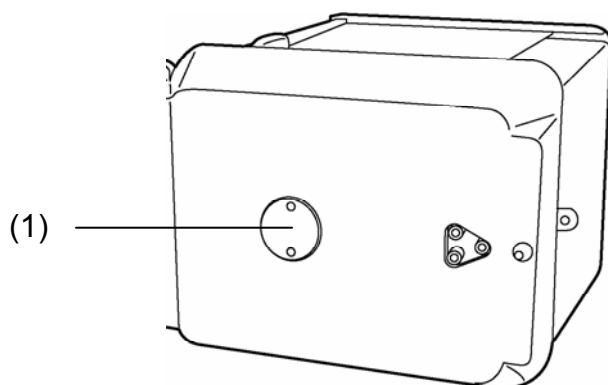

Fig. 1: Underfloor weighing device



CAUTION

- **Always ensure that all suspended objects are stable enough to hold the desired goods to be weighed safely (danger of breaking).**
- **Never suspend loads that exceed the stated maximum load (max) (danger of breaking)**

Always ensure that there are no persons, animals or objects that might be damaged underneath the load.



NOTE

After completing the underfloor weighing the opening on the bottom of the balance must always be closed (dust protection).

12 The menu

To adapt the behaviour of the balance to your requirements, go to the balance mode menu. Usually the default setting of the balance mode menu is such that you do not need to make any changes. If you encounter special conditions of use, go to the balance mode menu in order to set your balance according to your individual requirements.

12.1 Changing settings

To change the settings of specific functions, select the related functions.

Functions are changed by taking the following three steps:

- ⇒ **Call up menu**
- ⇒ **Set function**
- ⇒ **Confirm and store**

When setting a function the **ON/OFF**, **CAL** and **TARE** keys have special functions.

12.2 How to change settings

- **CAL key** = Select menu and pass through menu items from top to bottom (↓).
- **TARE key** = Select function.
After selecting the function on the display by pressing the **CAL** key, the change is invoked by pressing the **TARE** key.
- **CAL key** = Select one of the possible settings within the function. Passing through menu items from top to bottom.
- **TARE key** = Store the setting momentarily appearing on the display by actuating the **TARE** key.
The standstill display → shows the present setting for the function.
- **ON/OFF key** = Exit function

*Brief actuation of **ON/OFF** key:*
Back to previous menu.

*Long actuation of **ON/OFF** key:*
Back to weighing mode.

12.3 Call up menu

Please have a go and try to change a function yourself. Change the "Auto-Zero" function to OFF and then again to ON.

- ⇒ Turn on balance by pressing the **ON/OFF key**.
- ⇒ Actuate the **CAL** key until FUnC.SEL appears
- ⇒ Press the **TARE** key once until CAL appears
- ⇒ Press the **CAL** key once until trC :on appears
- ⇒ To confirm, press the **TARE** key once.
"Auto-Zero" function is now selected.
The standstill display → shows the current setting.

- ⇒ Press the **CAL** key

thereby means:

trC-oF Auto-Zero is switched off

trC-on Auto-Zero is switched on

Select trC-oF

- ⇒ Press the **TARE** key once
The colons appear when storing the changed trC: oF
- ⇒ Press **ON/OFF** key
To quit the menu keep the **ON/OFF**
key pressed longer than 2 sec.

Note:

If you wish to make several changes in the weighing mode menu you do not have to exit the menu after each change. You can make several changes one after the other and finally exit the menu

12.4 Selecting the menu

- ⇒ In weighing mode press the **[CAL]** key. First function "i-Cal" (ex.) appears.
- ⇒ The various functions of the menu are passed through by pressing the **[CAL]** key again.

	Weighing mode	
	Preset adjustment method (see ch. 8.3)	
	Not documented	
	Setting control display (see ch. 12.6)	
	Standard mode] Settings for stability and response (see chapter 13.1)
	Apportioning mode	
	Anti-convection mode	
	High-stability Mode	
	Entry to second level (application functions, menu group for individual settings)	
	Entry to third level (system settings menu group)	
	Entry to forth level (communication settings menu group)	
	Weighing mode	

12.5 Menu overview

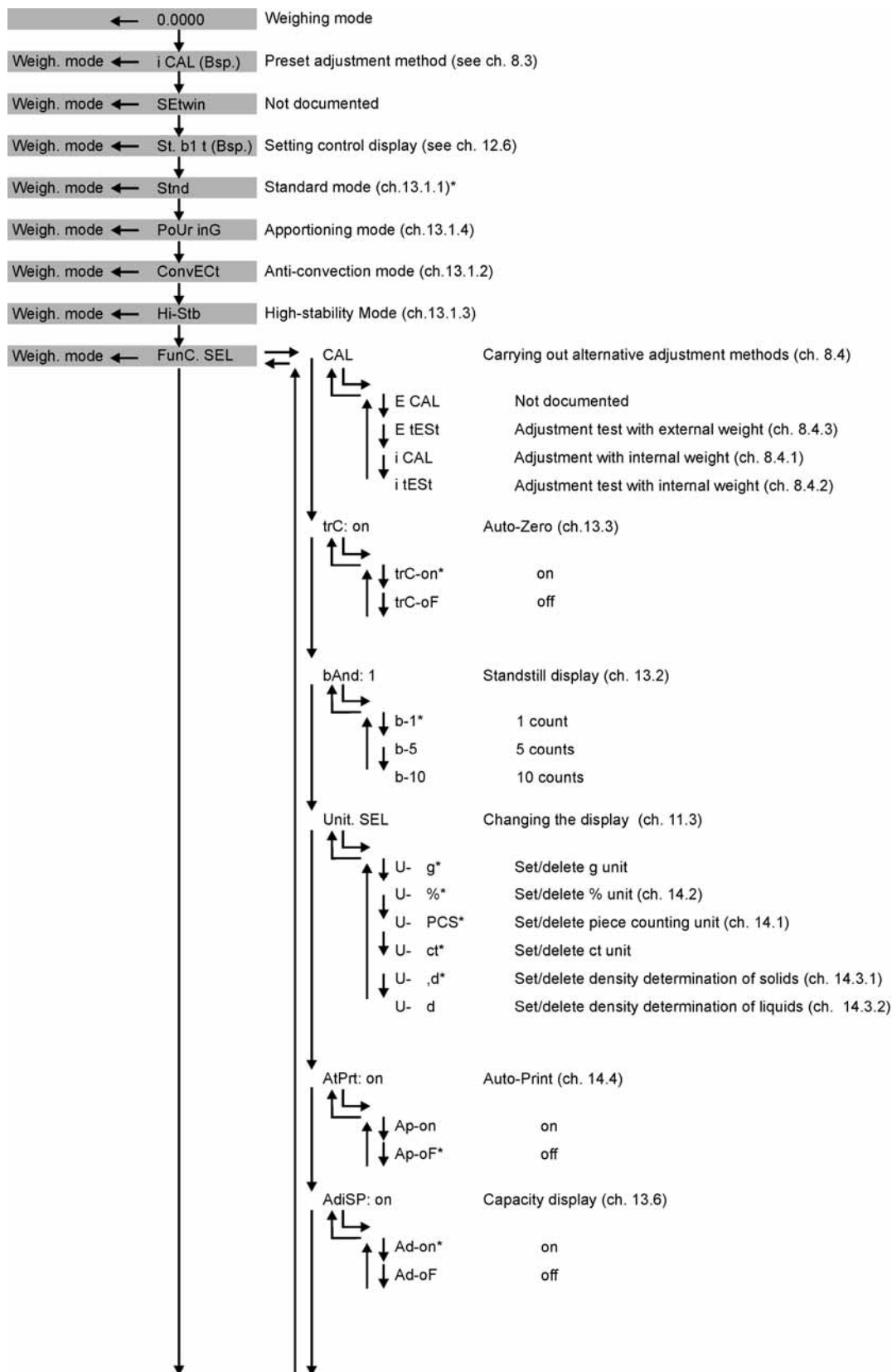

* = default setting

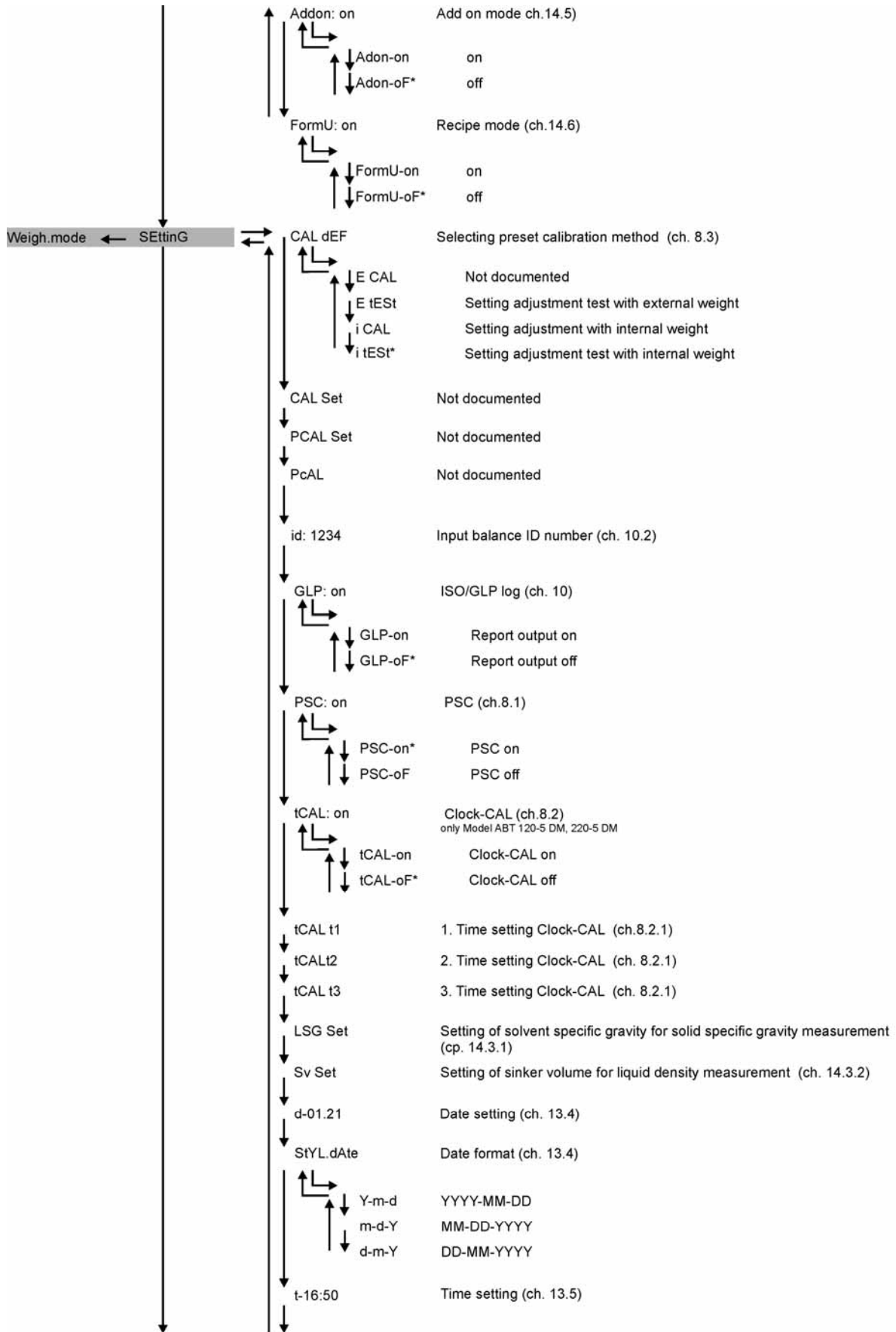

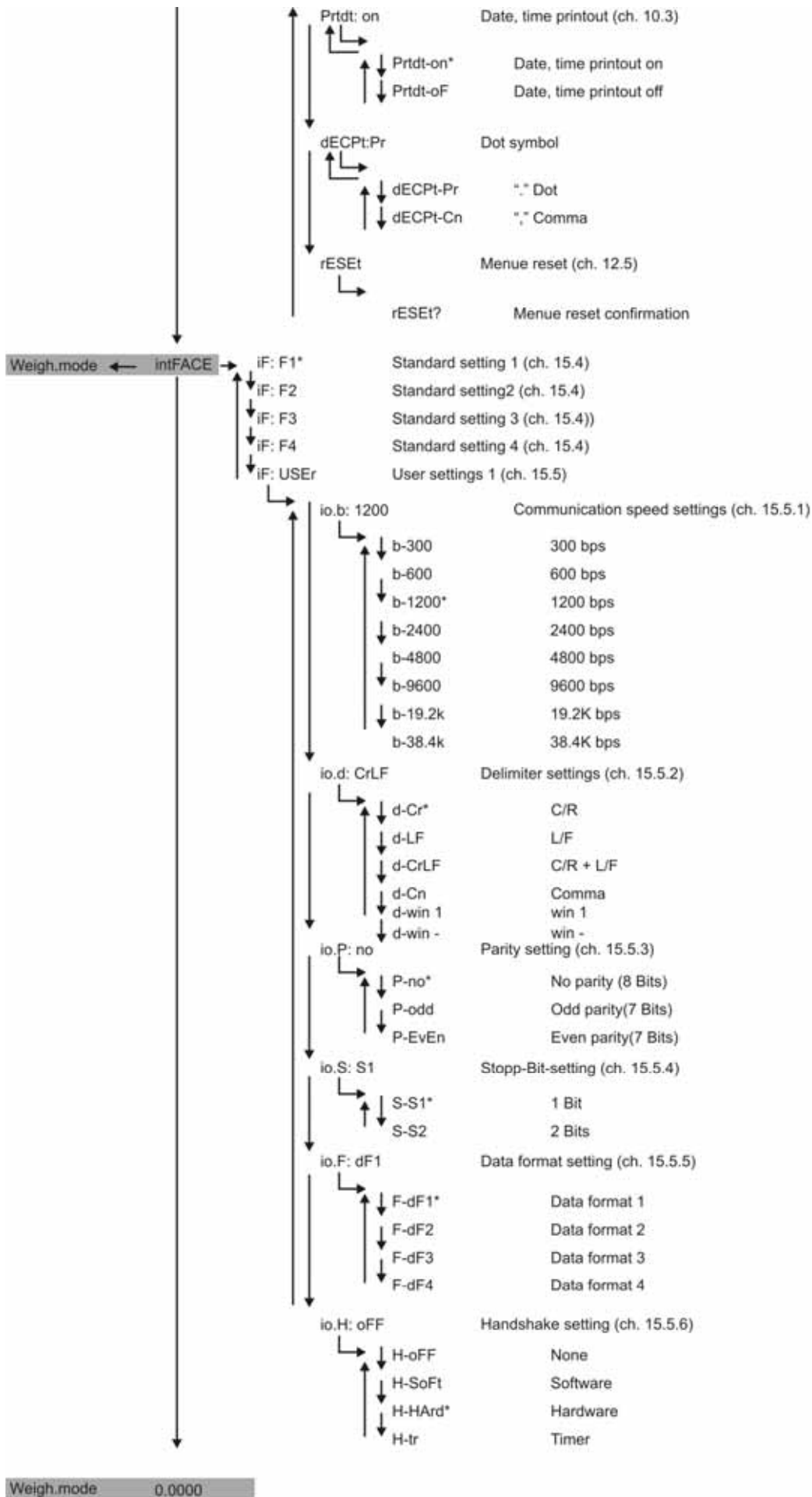

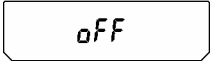
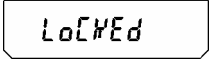
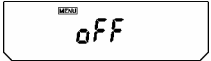
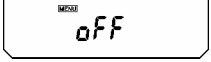
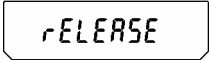
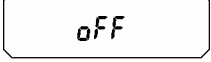

12.6 Menu Lock

The menu setting operations can be locked so that the settings cannot be inadvertently changed. This is called Menu Lock. The menu lock is activated with the following procedure.

	<p>Turn on the power supply for the balance and wait until "oFF" appears.</p>
	<p>Press the [CAL] key until "LoCKEd" appears. Menu is disabled, menu symbol appears. This is followed by a reappearance of "oFF".</p>
	<p>If a menu item selection is attempted in locked status, the message "LoCKEd" appears and the menu selection is not allowed. To deactivate menu lock, follow the sequence of operations below:</p>
	<p>Disconnect the balance from the power and connect again after a while.</p>
	<p>When "oFF" is displayed, press the [CAL] key until "rELASE" appears. The menu lock is deactivated.</p>
	

12.7 Resetting the menu

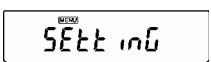
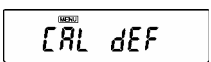
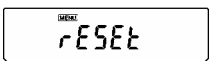
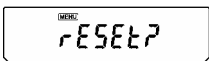
This will return all the settings to default. The reference value stored in previous use of piece counting or percentage conversion will also be cleared. The default settings are indicated with "#" on the Menu Map.

	<p>Press the [CAL] key repeatedly until "SettinG" appears.</p>
	<p>Press the [TARE] key. The display shows "CAL dEF".</p>
	<p>Press the [CAL] key repeatedly until "rESET" appears.</p>
	<p>Press the [TARE] key. The display shows confirmation enquiry "rESET?"</p>
	<p>Confirm by pressing the [TARE] key; balance automatically returns to weighing mode.</p>

12.8 Settings control display

To receive a confirmation of the current settings, repeatedly actuate the [CAL] key in weighing mode until "St. b1 t" (ex.) appears.

Appears when the automatic adjustment has been switched on by PSC or Clock-CAL.

Appears when the issue of the adjustment data is switched on.

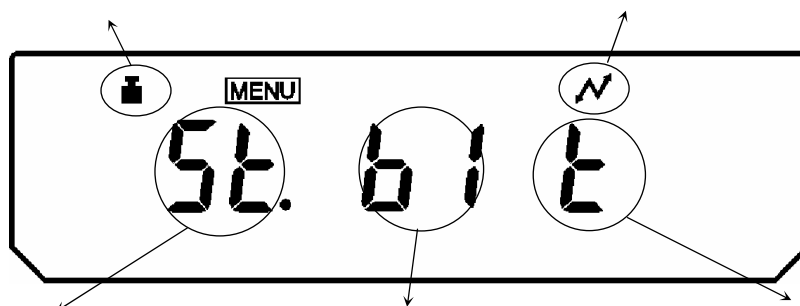

Stability and response setting

St: Standard mode
Co: Anti-convection mode
Hi: High-stability mode
Po: Apportioning mode

Stability and response setting

b1: 1 count
b5: 5 count
b10: 10 count

Appears when zero function is turned on.

The weight symbol is displayed when either automatic adjustment PSC or Clock-CAL or both functions are turned on.

13 Description of individual functions

13.1 Stability filter

Generally, data processing for greater stability slows the response and processing for higher response reduces stability. Balances of the series ABT are designed to ensure both qualities, that is, fast reaction time and high stability.

Most measurements can be carried out using default settings, that is, standard mode. In specific environmental conditions and for specific measuring purposes anti-convection, high stability or apportioning mode is available for you to use. The currently set mode is shown on the setting control display (see ch. 12.6).

13.1.1 Standard mode

This is the default setting. Use this mode unless stability or response has to be increased or reduced.

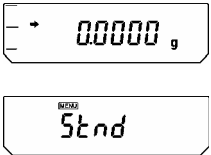
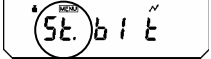
 <p>The image shows two parts of the setting control display. The top part shows a digital scale reading of 000000 g. The bottom part shows the mode selection screen with 'Stnd' (Standard mode) highlighted.</p>	<p>Repeatedly press the [CAL] key until "Stnd".</p>
<p>Setting control display</p>  <p>(when selecting standard mode)</p>	<p>To set standard mode, press the [TARE] key.</p> <p>Setting of this mode can be confirmed only in settings check display (see ch. 12.6).</p>

13.1.2 Anti-convection mode

If measurements have to be taken under unavoidable ambience conditions, (e. g. changing air condition systems) convection occurring within the weighing space may result in fluctuations in the display on the balance after the stability display has appeared. The small range (readability 0.01 mg) of series ABT is particularly susceptible to this effect.

Anti-convection mode adjusts the timing of appearance of the stability mark. Note that the stability mark will then appear at a late timing.

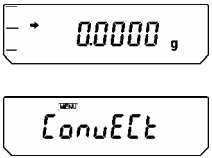
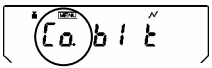
	<p>Repeatedly press the [CAL] key until "ConvECT" appears.</p>
<p>Setting control display</p>  <p>(when selecting anti-convection mode)</p>	<p>To set anti-convection mode, press the [TARE] key.</p> <p>Setting of this mode can be confirmed only in settings check display (see ch. 12.6).</p>

13.1.3 High-stability Mode

The balances of series ABT are designed to react only minimally to the effects of vibrations and drafts. However, if it must be set up in a location with poor conditions, use this function to reduce the effects of vibration or air current even further. There is a slight increase in the reaction time of the balance but the display itself is stabilized.

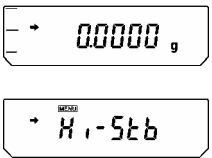
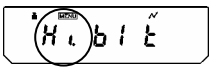

	<p>Repeatedly press the [CAL] key until "ConvECT" appears.</p>
<p>Setting control display</p>  <p>(when selecting high-stability mode)</p>	<p>To set high stability mode, press the [TARE] key.</p> <p>Setting of this mode can be confirmed only in settings check display (see ch. 12.6).</p>

13.1.4 Apportioning mode

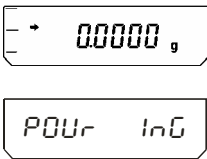
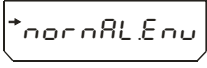
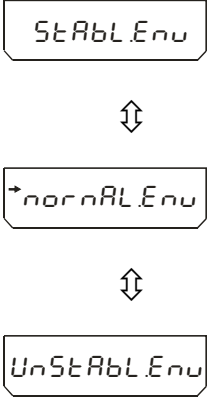
Use this function if you wish to increase display speed, e.g. during apportioning. However, please note that the balance is very susceptible to ambience conditions. You can set the degree of sensitivity according to site (quiet/unquiet).

	<p>Repeatedly press the [CAL] key until "PoUr inG" appears.</p>
	<p>Press the [TARE] key; display shows current setting of sensitivity</p> <p>Setting of this mode can be confirmed only in settings check display (see ch. 11.6).</p>
	<p>You can use the [CAL] key to select between the following settings:</p> <p>"StAbL.Env" very quiet site/sensitive and fast</p> <p>"normL.Env" normal site/ medium setting</p> <p>" UnStAbL.Env " very unquiet site/insensitive but slow</p> <p>The current setting is indicated by the standstill display (➔).</p>
	<p>Confirm your selection by pressing the [TARE] key</p>

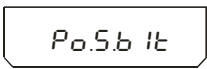
For mode setting in setting control display (see ch.12.6):



	<p>very quiet site/sensitive and fast</p>
	<p>normal site/ medium setting</p>
	<p>very unquiet site/insensitive but slow</p>

13.2 Standstill display

If the display shows the stability display (➔) the balance is in a stable status. The condition for judging stability is user-selectable. There are three levels to select: 1 count, 5 counts and 10 counts. The default setting is 1 count.

The setting of the standstill display can be checked on the setting control display (see ch.12.6).

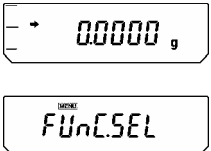
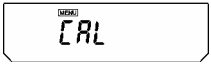
Setting the standstill display

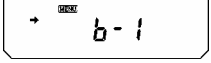
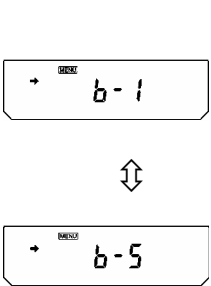
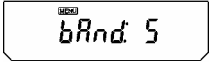
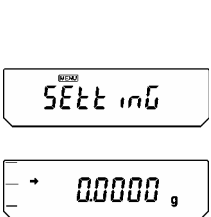

	<p>Repeatedly press the [CAL] key until "FUnC.SEL" appears.</p>
	<p>Press [TARE] key</p>
 <p>(Example)</p>	<p>Repeatedly press the [CAL] key until the current "b And:***" setting appears.</p>
	<p>Press [TARE] key</p>
	<p>You can use the [CAL] key to select between the following settings:</p> <p>"b-1" 1 count</p> <p>"b-1" 5 count</p> <p>"b-1" 10 count</p> <p>The current setting is marked by the stability symbol (➔).</p>
	<p>Confirm your selection by pressing the [TARE] key</p>
	<p>To exit the function, press the [ON/OFF] key.</p> <p>Brief actuation of ON/OFF key: Back to previous menu.</p> <p>Long actuation of ON/OFF key: Back to weighing mode.</p>

13.3 Auto Zero

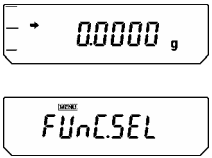

This function is used to tare small variations in weight automatically.

In the event that small quantities are removed or added to the material to be weighed, incorrect weighing results can be displayed due to the “stability compensation“ in the balance. (e.g. slow flow of liquids from a container placed on the balance, evaporating processes).

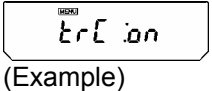
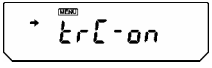
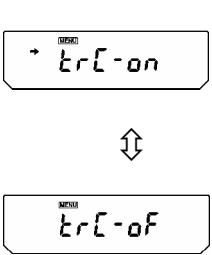
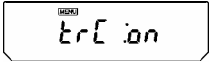
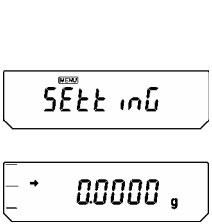
When apportioning involves small variations of weight, it is advisable to switch off this function.

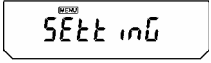
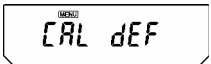
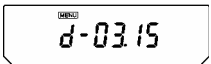
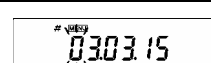
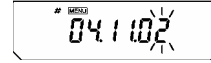

	<p>Repeatedly press the [CAL] key until "FUnC.SEL" appears.</p>
	<p>Press [TARE] key</p>
 <p>(Example)</p>	<p>Repeatedly press the [CAL] key until the current "trC:***" setting appears.</p>
	<p>Press [TARE] key</p>
	<p>You can use the [CAL] key to select between the following settings:</p> <p>“trC-on”Function activated</p> <p>“trC-of”Function deactivated</p> <p>The current setting is marked by the stability symbol (→).</p>
	<p>Confirm your selection by pressing the [TARE] key</p>
	<p>To exit the function, press the [ON/OFF] key.</p> <p>Brief actuation of ON/OFF key: Back to previous menu.</p> <p>Long actuation of ON/OFF key: Back to weighing mode.</p>

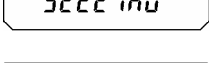
13.4 Setting date

 	<p>Press the [CAL] key repeatedly until "SettinG" appears.</p>
	<p>Press the [TARE] key.</p>
	<p>Repeatedly press the [CAL] key until "d-MM.DD" appears (MM and DD provide two digits each, indicating month and day).</p>
 (15. march 2003)	<p>Press the [TARE] key. The date currently set appears. In the upper part of the display panel, the [MENU] symbol and the # symbol appear in order to indicate numerical input status. The leftmost digit blinks.</p>
 (2. nov. 2004)	<p>When the [UNIT] key is pressed, the numerical of the blinking digit increases by 1 at a time. You can determine the value of the flashing digit, or shift the flashing digit by one position to the right, by pressing the [PRINT] key. Confirm your setting by pressing the [TARE] key.</p>
 	<p>To exit the function, press the [ON/OFF] key.</p> <p>Brief actuation of ON/OFF key: Back to previous menu.</p> <p>Long actuation of ON/OFF key: Back to weighing mode.</p>

13.5 Setting time

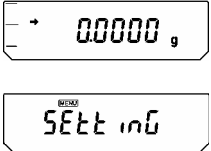
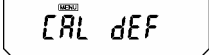
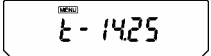
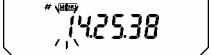
Balances of the series ABT are equipped with an integrated clock. Set the clock before using the functions Clock-CAL (ch. 8.2) or GLP log (ch. 10). Note that the current time is displayed at the stand by status (ch. 7.5.1).

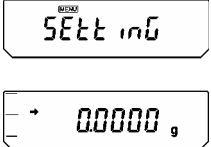
	<p>Press the [CAL] key repeatedly until "SettinG" appears.</p>
	<p>Press the [TARE] key.</p>
	<p>Repeatedly actuate the [CAL] key until "t-HH.MM" appears (HH and MM provide 2 digits each for hour and minute display).</p>
	<p>Press the [TARE] key. The currently set time appears. In the upper part of the display panel, the [MENU] symbol and the # symbol appear in order to indicate numerical input status. The leftmost digit blinks.</p>
	<p>When the [UNIT] key is pressed, the numerical of the blinking digit increases by 1 at a time. You can determine the value of the flashing digit, or shift the flashing digit by one position to the right, by pressing the [PRINT] key. Confirm your setting by pressing the [TARE] key.</p>
	<p>To exit the function, press the [ON/OFF] key.</p> <p>Brief actuation of ON/OFF key: Back to previous menu.</p> <p>Long actuation of ON/OFF key: Back to weighing mode.</p>

13.6 Capacity display

This function displays a bar graph representation of the load on the weighing plate. This may be used to prevent sudden appearance of "oL" (overload) during measurement.

It is possible to turn the display of capacity on or off.

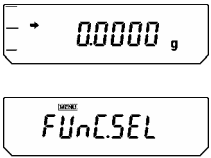
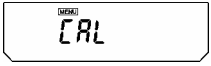
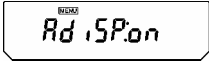
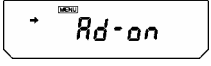
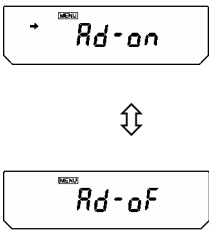
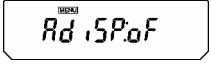
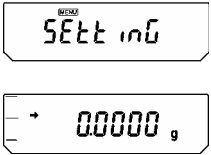
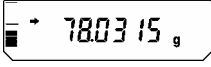
	<p>Repeatedly press the [CAL] key until "FUnC.SEL" appears.</p>
	<p>Press [TARE] key</p>
	<p>Repeatedly press the [CAL] key until the current "AdiSP:***" setting appears.</p>
	<p>Press [TARE] key</p>
	<p>You can use the [CAL] key to select between the following settings:</p> <p>“Ad-on” Function activated</p> <p>“Ad-of” Function deactivated</p> <p>The current setting is indicated by the standstill display (→).</p>
	<p>Confirm your selection by pressing the [TARE] key</p>
	<p>To exit the function, press the [ON/OFF] key.</p> <p>Brief actuation of ON/OFF key: Back to previous menu.</p> <p>Long actuation of ON/OFF key: Back to weighing mode.</p>
	<p>Display will appear when about one third of capacity is exhausted.</p>

14 Application Functions





14.1 Parts counting

With parts counting you can either count parts into a container or remove parts from a container. To count a greater number of parts the average weight per part has to be determined with a small quantity (reference quantity). The larger the reference quantity, the higher the counting exactness. High reference must be selected for small parts or parts with considerably different sizes.

The process has four steps:

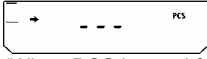
- Tare the weighing container
- Determine the reference unit
- Weigh in the reference unit
- Count the items

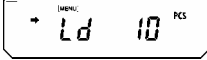
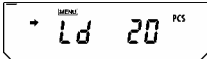
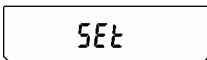
Condition: Function "U- PSC" activated (ch. 11.3)

  (When PCS is used for the first time)	Repeatedly press the [UNIT] until display is in percentage mode. The display symbol PCS pops up.
	If you are using a weighing container use the [TARE] key for taring.
	To determine the reference piece number, place 10, 20, 50 or 100 counting parts on the balance.
	Press the [CAL] key
	Repeated pressing of the [CAL] key allows the change between the following reference piece numbers "Ld 10", "Ld 20", "Ld 50" and "Ld 100". Important: The larger the reference quantity, the more accurate the parts counting.
 (When loading 20 pieces)  	When standstill control (→) is complete, confirm your reference piece number by pressing the [TARE] key. The display shows "SEt" for several seconds and the stored reference piece number is displayed.

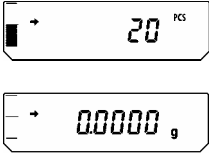
	<p>Remove reference weight.</p> <p>Now you can fill the items to be counted into the container. The respective quantity is shown in the display.</p>
	<p>Repeated pressing of the [UNIT] key changes the display value, e. g.: [g] → [%] → [Pcs] → [ct]</p>







Note:

Error message "Err 20" indicates that the weight for the reference piece number is too low.

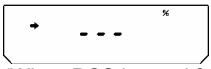
14.2 Percent determination

Percent weighing allows to display weight in percent, in relation to a reference weight. The displayed weighing value is stored as a standard percent value (default setting: 100%).

Condition: Function "U- %" is activated (ch. 11.3)

  <p>(When PCS is used for the first time)</p>	<p>Repeatedly press the [UNIT] key until the display is in percentage determination mode. The display symbol % pops up.</p>
	<p>If you are using a weighing container use the [TARE] key for taring.</p>
	<p>Put on reference weight (=100%) (minimum weight: Readability d x 100)</p>
	<p>When standstill control (➔) is complete, press the [CAL] key. The reference weight is saved.</p>
	<p>Remove reference weight.</p> <p>From now on the placed weight will be shown as %.</p>
	<p>Repeated pressing of the [UNIT] key changes the display value, e. g.: [g] → [%] → [Pcs] → [ct]</p>

14.3 Density determination

Density determination with the help of the flush-mounted platform facility is described in the following.

Density determination becomes even easier when an optional set for density determination is applied. For further information please refer to the operating instructions enclosed with the set for density determination.

1. Remove the below-weigh hook cover on the floor of the balance, after removing the two fixing screws.
2. Hang the user-prepared hanging pan from the below-weigh hook and sink that hanging pan into the sample liquid in the tank.

14.3.1 Density determination of solids



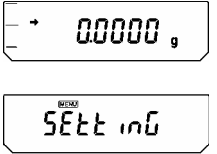
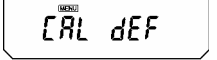
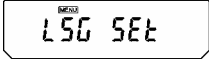
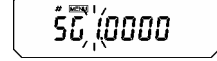
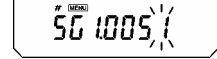
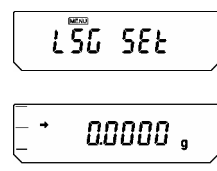

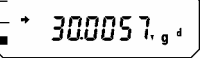
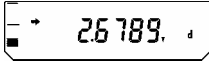
Condition: Function ",d" (density of solids) is activated. See Chapter 11.3.

	Press the [CAL] key repeatedly until "SettinG" appears.
	Press the [TARE] key.
	Repeatedly actuate the [CAL] key until "LSG SET" appears
 (Example)	Press the [TARE] key. The currently set density for the liquid to be measured appears. In the upper part of the display panel, the [MENU] symbol and the # symbol appear in order to indicate numerical input status. The leftmost digit blinks.
 (Example)	Enter density for your liquid to be measured. When the [UNIT] key is pressed, the numerical of the blinking digit increases by 1 at a time. You can determine the value of the flashing digit, or shift the flashing digit by one position to the right, by pressing the [PRINT] key. Confirm your setting by pressing the [TARE] key.
	Repeatedly press the [ON/OFF] key until the balance is in weighing mode.

	<p>Repeatedly press the [UNIT] key until the balance is in density determination mode for solids "d". Note that "g" also appears during weight measurement in air.</p>
	<p>Press the [TARE] key. Place the item to be measured on the weighing pan.</p> <p>When standstill control is complete, press the [CAL] key</p>
	<p>Place the item to be measured on the immersed hanging weighing pan. The display is showing the density of the measured item. "dSP oL" may be displayed when nothing is on the weighing pan, which is normal.</p>

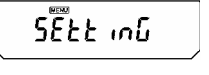
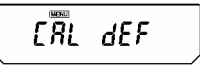
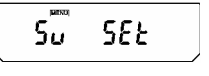
14.3.2 Determining density of liquids

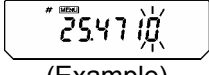
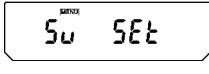
Condition: Function "d" (density of liquids) is activated. See Chapter 11.3.

 	<p>Press the [CAL] key repeatedly until "SettinG" appears.</p>
	<p>Press the [TARE] key.</p>
	<p>Repeatedly actuate the [CAL] key until "Sv SEt" appears</p>
 (Example)	<p>Press the [TARE] key. The currently set density for the body to be immersed appears. In the upper part of the display panel, the [MENU] symbol and the # symbol appear in order to indicate numerical input status. The leftmost digit blinks.</p>
 (Example)	<p>Enter density for your body to be immersed. When the [UNIT] key is pressed, the numerical of the blinking digit increases by 1 at a time. You can determine the value of the flashing digit, or shift the flashing digit by one position to the right, by pressing the [PRINT] key. Confirm your setting by pressing the [TARE] key.</p>
 	<p>Repeatedly press the [ON/OFF] key until the balance is in weighing mode.</p>

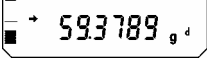
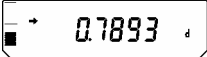



	<p>Repeatedly press the [UNIT] key until the balance is in density determination mode for liquids "d". Note that "g" also appears during weight measurement in air.</p> <p>Press the [TARE] key. Place the body to be immersed on the weighing pan.</p>
	<p>When standstill control is complete, press the [CAL] key</p>
	<p>Immerse the body to be immersed without bubbles developing. The display is showing the density of the sample. "dSP oL" may be displayed when nothing is on the weighing pan, which is normal.</p>

14.4 Auto Print

Using Auto Print allows measurement results to be automatically output via the RS-232C interface without pressing the **[PRINT]** key individually with every measurement. An issue will be made after standstill control (➔) is complete. The next measurement is done after removing the items from the weighing plate and the display is returning to a value within the ± 3 -fold of the zero range.

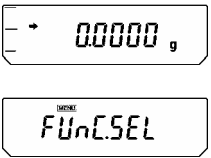
Important:

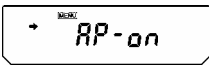
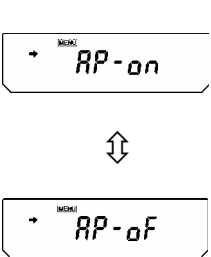
- ⇒ This mode can be applied to any unit.
- ⇒ The initial load of the balance must be kept within the ± 5 -fold of the zero range.
- ⇒ Weight of sample $\geq 10 \times$ zero range (zero range = 0.25 e)

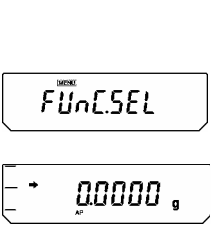
	<p>Repeatedly press the [CAL] key until "FUnC.SEL" appears.</p>
	<p>Press [TARE] key</p>
 <p>(Example)</p>	<p>Repeatedly press the [CAL] key until the current "AtPrt:***" setting appears.</p>
	<p>Press [TARE] key</p>
	<p>You can use the [CAL] key to select between the following settings:</p> <p>“ AtPrt-on ” Function activated</p> <p>“ AtPrt-of ” Function deactivated</p> <p>The current setting is indicated by the standstill display (➔).</p>
	<p>Confirm your selection by pressing the [TARE] key</p>
	<p>To exit the function, press the [ON/OFF] key.</p> <p>Brief actuation of ON/OFF key: Back to previous menu.</p> <p>Long actuation of ON/OFF key: Back to weighing mode. Whilst the auto print function is active the display keeps showing the [AP] symbol.</p>

14.5 Add up mode

An optional number of single weighing processes are automatically added up to a total sum, e.g. all single weighing processes of a batch or if you have to carry out a great number of measurements of small samples.



When the standstill control (➔) is complete the weighing value is automatically issued to the optional printer. The displayed value is added into the total adding memory. Afterwards automatic taring will take place. This is repeated newly every subsequent time a new sample is placed on the weighing pan. When the last single weighing process is finished, press the **[ON/OFF]** key to receive the total sum ("TOTAL=").

Important:

- ⇒ This mode can be applied to any unit.
- ⇒ The initial load of the balance must be kept within the ± 5 -fold of the zero range.
- ⇒ Weight of sample $\geq 10 \times$ zero range (zero range = 0.25 e)
- ⇒ If during the use of multiple range balances the smallest readability digit was turned off by pressing the **[1d/10d]** key, evaluation is based on the latest add-on value displayed before.

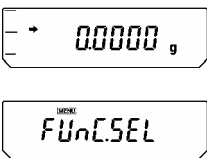
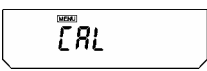
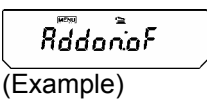
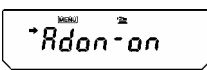
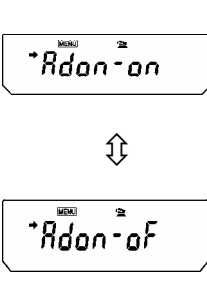
Activate function:

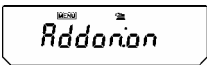
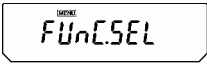
	Repeatedly press the [CAL] key until "FUnC.SEL" appears.
	Press [TARE] key
	Repeatedly press the [CAL] key until the current "Adon:***" setting appears.
	Press [TARE] key
	You can use the [CAL] key to select between the following settings: “ Adon-on ” Function activated “ Adon-oF ” Function deactivated The current setting is indicated by the standstill display (➔).

	<p>Confirm your selection by pressing the [TARE] key. Printout "---- ---- ADDON MODE -----" takes place.</p>
 	<p>To exit the function, press the [ON/OFF] key.</p> <p>Brief actuation of ON/OFF key: Back to previous menu.</p> <p>Long actuation of ON/OFF key: Back to weighing mode. Whilst the add-on function is active, the display keeps showing the add-on symbol [].</p>

Add up:

Operation	Display
<p>When using a container, place this on the weighing plate and tare. Prior to weighing the component press the [PRINT] key 1x. Weigh first component.</p>	<p>5.0003 g</p>
<p>Wait until standstill display (➔) appears, the weighing value for the first component (CMP001) will be issued automatically to the optional printer. This is followed by automatic taring.</p>	<p>0.0000 g</p>
<p>Weigh second component</p>	<p>5.0017 g</p>
<p>Wait until standstill display (➔) appears, the weighing value for the second component (CMP002) will be issued automatically to the optional printer. This is followed by automatic taring.</p>	<p>0.0000 g</p>
<p>Weigh third component</p>	<p>5.0010 g</p>
<p>When the last single weighing process is finished, press the [ON/OFF] key to receive the total sum ("TOTAL=").</p>	<p>15.0030 g</p>

Printout:

---ADDON Mode---	
CMP001=	5,0003 g
CMP002=	5,0017 g
CMP003=	5,0010 g
TOTAL=	15,0030 g

Note: Only one function at a time may be activated (on) when working with functions auto print, add-on and recipe.
Whilst the function is active, automatic adjustment (PSC/Clock-CAL) does not take place. A flashing  symbol, however, indicates that adjustment is required.

14.6 Recipe mode

The formula function allows to add on various components of a mixture. The total weight of all components can be invoked to check (separate memory for the weight of tare vessel and recipe components).

Activate function "FormU: on" (see chap. 14.5 Add up):

Whilst the recipe function is active, the display keeps showing the "FormU -on" symbol [ M].

Operation	Display
When using a container, place this on the weighing plate and tare.	0.0000 g
Weigh first component.	0.5361 g
When standstill control (➔) is complete, the weighing value of the first component (CMP001) is issued to the optional printer by pressing the [PRINT] key. The displayed value is added into the total adding memory. Afterwards automatic taring will take place.	0.5361 g ↓ 0.0000 g
Weigh second component	0.5422 g
When standstill control (➔) is complete, the weighing value of the second component (CMP002) is issued to the optional printer by pressing the [PRINT] key. The displayed value is added into the total adding memory. Afterwards automatic taring will take place.	0.54221 g ↓ 0.0000 g

Place further components	0.4488 g
When the last single weighing process is complete press [ON/OFF] key to receive the total sum (Total).	1.5271 g
Remove weight from weighing plate. The balance is now ready for further measurements.	

Printout:

---Formulation Mode---	
CMP001=	0,5361 g
CMP002=	0,5422 g
CMP003=	0,4488 g
TOTAL=	1,5271 g

Note: Only one function at a time may be activated (on) when working with functions auto print, add-on and recipe. Whilst the function is active, automatic adjustment (PSC/Clock-CAL) does not take place. A flashing  symbol, however, indicates that adjustment is required.

15 Data output

15.1 RS 232C interface

Pin allocation of balance output plug:

PIN No.	Signal
2	TXD
3	RXD
6	DSR
7	SG
20	DTR
5	CTS
4	RTS

15.2 Data Formats

Note: _ space character and DL the delimiter code.

1. Input Data Format
COMMAND CODE + DL (see 15.2.3)
2. Output data format
 - In weighing mode:

(ex.) S -200.000g_DL
stability _____ polarity

Polarity data

Positive: space character ()
Negative: minus (-)

Stability information (when output includes stability information)

Stable : S
Unstable : U

- In "oL" or "-oL" display

(ex.) U -oL DL
stability _____ polarity

Polarity data

Positive: space character (_)
Negative: minus (-)

Stability data (when output includes stability information)

Stable : S
Unstable : U

3. Data format
 - ASCII (JIS) code
 - Baud rate, parity (and bit length), delimiter, stop bit, format, and handshake differ by menu item selections.

15.3 Remote control instructions

Attention:

Inputting characters and command codes not shown here into the balance may not only alter the previous settings but may also impair proper measurement.

If by mistake characters or commands not shown here are entered into the balance, immediately unplug the power supply cable and wait about ten seconds before plugging again.





Command Code	Function	Description
D01	Continuous output	The balance continuously outputs every 110ms .
D05	1 time output	Corresponds to [PRINT] key
D06	Auto Print	See 14.4
D07	1 time output with stability information	The status of the stability mark is appended to the head of the data with output. S: when the standstill display appears U: when standstill display does not appear
D08	1 time output at stability	After command input, the data are output at the first appearance of the standstill display.
D09	Halt output	Auto Print and continuous output halted
Q	ON/OFF switching	Switches between standby status and measurement status.
T	Taring	Corresponds to the [O/T] key
TS	Taring after stability wait	After command input, taring is done at the first appearance of the stability mark.
C18	Measurement span calibration	
+	Measurements in add-up mode	See ch. 14.5
R	Total reset	All application measurements terminated and reset
mg	mg unit	
PERCENT	Percent determination	
PCS	Parts counting	
CT	ct unit	
SDENCE	Density of solids	
LDENCE	Density of liquids	
%	100% setting	
G	g, % switching	
- g	g unit removal	
- mg	mg unit removal	
- PERCENT	Deleting percentage determination t	
- PCS	Piece counting removal	
- CT	ct unit removal	
- SDENCE	Solid specific gravity removal	
- LDENCE	Liquid specific gravity removal	

C02	High-stability mode setting	
C13	Anti-convection mode setting	
C14	Standard mode setting	
C05	Standstill display, setting to 1 count	
C06	Standstill display, setting to 5 count	
C15	Standstill display, setting to 10 count	
C07	Auto Zero on	
C08	Auto zero off	
C10	Autom. CAL on	
C11	Autom. CAL off	
C17	Display setting status	

15.4 Standard Settings

	Display for menu selection	Baud Rate	Delimiter	Parity (Bit length)	Stop bit	Data format	Handshake
Standard setting 1	iF:F1	1200	C/R	None (8)	1	dF1	Hardware
Standard setting 2	iF:F2	1200	C/R	None (8)	1	dF2	Hardware
Standard setting 3	iF:F3	2400	C/R+L/F	Even (7)	1	dF3	Hardware
Standard setting 4	iF:F4	1200	C/R+L/F	Odd (7)	1	dF4	Hardware
Operator settings (see 15.5)	iF:USEr	User settings	User settings	User settings	User settings	User settings	User settings
KERN-YKB-01N	iF:USEr	1200	C/R	None (8)	1	dF1	off

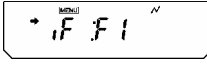
Selecting one of standard Settings:

 	Repeatedly press the [CAL] key until "intFACE" appears.
	Press [TARE] key
	Repeatedly press the [CAL] key until the desired standard setting appears. Confirm your selection by pressing the [TARE] key.
	Repeatedly press the [ON/OFF] key. The balance returns to tolerance weighing mode.

15.5 User Settings

The user setting allows individual setting for each item in communication settings.

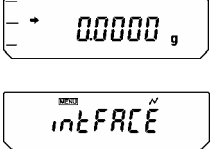
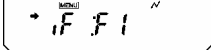
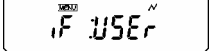
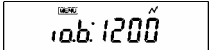
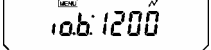
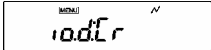
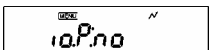
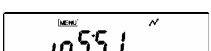
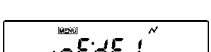
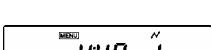
	<p>Repeatedly press the [CAL] key until "intFACE" appears.</p>
	<p>Press [TARE] key</p>
	<p>Repeatedly press the [CAL] key until "iF:USEr" appears.</p>
 <p>(Example)</p>	<p>Press [TARE] key</p>
     	<p>Use the [CAL] key to select between the following settings (The **** reflect the current setting, two to four characters):</p> <ul style="list-style-type: none"> “io.b:****” Speed of communication “io.d:****” Delimiter “io.P:****” Parity “io.S:****” Stop bit “io.F:****” Data format “io.H:****” handshake
	<p>Confirm your selection by pressing the [TARE] key and set the parameters you require as follows:</p>

15.5.1 Communication speed settings

1. The display changes from "io.b:****" to "b-300". Pressing the **[CAL]** key changes the display. The standstill display (➔) marks the current setting.

Display during setting	b-300	b-600	b-1200	b-2400	b-4800
Setting specifics	300bps Baud Rate	600bps Baud Rate	1200bps Baud Rate	2400bps Baud Rate	4800bps Baud Rate

Display during setting	b-9600	b-19.2K	b-38.4K
Setting specifics	9600bps Baud Rate	19.2Kbps Baud Rate	38.4Kbps Baud Rate

2. Confirm your desired setting by pressing the **[TARE]** key.
3. To return to "io.S:****", press the **[ON/OFF]** key.

15.5.2 Delimiter settings

1. The display changes from "io.d:****" to "d-Cr". Pressing the **[CAL]** key changes the display. The standstill display (➔) marks the current setting.

Display during setting	d-Cr	d-LF	d-CrLF	d-Cn	d-win 1	d-win -
Setting specifics	C/R	L/F	C/R + L/F	Comma	Not documented	

2. Confirm your desired setting by pressing the **[TARE]** key.
3. To return to "io.d:****", press the **[ON/OFF]** key.

15.5.3 Parity settings

1. The display changes from "io.P:****" to "P-no". Pressing the **[CAL]** key changes the display. The standstill display (➔) marks the current setting.

Display during setting	P-no	P-odd	P-EvEn
Setting specifics	No parity (eight bits)	Odd parity (seven bits)	Even parity (seven bits)

2. Confirm your desired setting by pressing the **[TARE]** key.
3. To return to "io.P:****", press the **[ON/OFF]** key.

15.5.4 Stop bit settings

1. The display changes from "io.S:****" to "S-S1". Pressing the **[CAL]** key changes the display. The standstill display (➔) marks the current setting.

Display during setting	S-S1	S-S2
Setting specifics	Stop bit, 1 bit	Stop bit, 2bit

2. Confirm your desired setting by pressing the **[TARE]** key.
3. To return to "io.S:****", press the **[ON/OFF]** key.

15.5.5 Input-output data format settings

1. The display changes from "io.F:****" to " F-dF1". Pressing the **[CAL]** key changes the display. The standstill display (➔) marks the current setting.

Display during setting	F-dF1	F-dF2	F-dF3	F-dF4
Setting specifics	Data format 1. Standard format	Data format 2. Not documented	Data format 3. Not documented	Data format 4. Not documented

2. Confirm your desired setting by pressing the **[TARE]** key.
3. To return to "io.F:****", press the **[ON/OFF]** key.

Note: When set to data format 2, the balance will always send a process result against commands from the computer.

15.5.6 Handshake settings

1. The display changes from "io.H:****" to " H-oFF". Pressing the **[CAL]** key changes the display. The standstill display (➔) marks the current setting.

Display during setting	H-oFF	H-Soft	H-HArd	H-tr
Setting specifics	No handshake	Software handshake	Hardware handshake	Timer handshake

2. Confirm your desired setting by pressing the **[TARE]** key.
3. To return to "io.H:****", press the **[ON/OFF]** key.

16 Service, maintenance, disposal

16.1 Cleaning

Before cleaning, please disconnect the appliance from the operating voltage.

Please do not use aggressive cleaning agents (solvents or similar agents), but a cloth dampened with mild soap suds. Ensure that no liquid penetrates into the device and wipe with a dry soft cloth.

Loose residue sample/powder can be removed carefully with a brush or manual vacuum cleaner.

Spilled weighing goods must be removed immediately.

16.2 Service, maintenance

The appliance may only be opened by trained service technicians who are authorized by KERN.

Before opening, disconnect from power supply.

16.3 Disposal

Disposal of packaging and appliance must be carried out by operator according to valid national or regional law of the location where the appliance is used.

17 Instant help

In case of an error in the program process, briefly turn off the balance and disconnect from power supply. The weighing process must then be restarted from the beginning.

Error code table:

Error code display	Explication	Remedy
CAL E2	High zero point shift during adjustment	Remove items from the weighing pan.
CAL E3	Great deviation of measuring values in PCAL.	Use correct adjusting weight.
CAL E4	Great deviation of measuring values during adjustment	
CHE X (X is a numeral) (when the display stops here)	Internal malfunction	Please contact a service representative.
Err 0X (X is a numeral)	Internal malfunction	Please contact a service representative.
Err 20	An improper value setting was attempted.	Enter the correct numbers or decimal points.
Err 24	Power voltage error	Check the power voltage .

Possible causes of errors:

When	Symptom	Possible causes	Remedy
Before measurement	Nothing appears in the display.	The AC adapter is not securely connected. The power switchboard of the room is turned off. The power voltage is incorrect.	Check power supply and connect correctly.
During measurement	The display fluctuates. The standstill display does not appear fast enough. The measured results have poor repeatability. "CAL d" appears frequently.	Vibrations or draft.	Change the installation site. Change stability and reaction settings or standstill display.

		Attempting to measure volatile substances	Measure with a lid on it.
		The weighed item is electrically charged.	Measure in a metal container. Measure with a metal object larger than the items.
		Sample temperature and temperature inside weighing space differ.	Measure at the same temperature. Leave the item in the chamber before measurement. Change to high-stability mode.
		Draft in weighing space.	Leave the glass doors of the weighing chamber open 1 to 2 cm wide when not in use.
		Effects of electronic noise or strong electromagnetic waves	Move away from the noise source.
		Internal trouble with the balance	Contact a service representative.
	"oL" or "-oL" is displayed	The load on the weighing pan is too large. The weighing pan is detached.	Use within the weighing capacity. Place the weighing pan on correctly.
	Automatic adjustment carried out frequently.	Severe temperature variations in the room or the instrument	Move to a location with less temperature fluctuation.
	Display is faulty.	Adjustment is not carried out.	Carry out correct adjustment.
		No taring to zero before weighing.	To reset the display before weighing, actuate the [TARE] key.
	The desired weighing unit cannot be called by [UNIT] key.	Unit was not activated beforehand.	Set unit beforehand.
	Cannot transmit or receive data to or from computer or device.	Communication settings are wrong.	Make the proper communication settings.
	Error message appears.		Refer to the error code table.
During adjustment	Error message appears.		Refer to the error code table.
During menu item selection	The menu settings cannot be changed.	The menu is locked	Remove the menu lock.